

Panasonic®

Personal Computer

OPERATING INSTRUCTIONS

Model No. CF-E1M

Contents

Getting Started

Read Me First.....	3
Names and Functions of Parts	8
First-time Operation	11
Using the Mouse	15

Operation

Starting Up/Shutting Down	16
Starting Up	16
Shutting Down (power off your computer)	17
Starting Up Your Computer Quickly	18
Conserving Power	20
Setting the Sound Volume	22
DVD-ROM Drive	24
Modem	26
VisualBright	27
Using USB Devices (e.g., FDD, Printer)	28
Using PC Cards	31
Using Audio Devices	32
Adding Memory	33
DV Capture	36
Using Image Files	43
Setup Utility	49

Troubleshooting

List of Error Codes	51
Dealing With Problems	52
Troubleshooting Suggestions	53
Reinstalling Software	57

Appendix

LIMITED USE LICENSE AGREEMENT	59
Installing Windows 98 Related Files	60
Specifications	61
LIMITED WARRANTY	62

98

For assistance, please call :1-800-211-PANA (7262)
or send e-mail to :consumerproducts@panasonic.com
or visit us at www.panasonic.com (U.S.A.)

Getting Started

Operation

Troubleshooting

Appendix

Customer's Record

Model No. ¹	Dealer's Name
Serial No.	
or	
Code No.	Dealer's Address
Product Key Code ²	
Date of Purchase	

*1 For the Model No., insert the 5 digit number (for example, CF-E1M) located on the right side of the computer.

*2 For Product Key Code, write down the alphanumeric Product Key Code, shown on the "Certificate of Authenticity" located on the right side of the computer.

Introduction

Thank you for purchasing the Panasonic computer. Read the operating instructions thoroughly for proper operation of your new computer.

Illustrations in this Manual

- NOTE:** **NOTE** provides a useful fact or helpful information.
- CAUTION:** **CAUTION** indicates a condition that may result in minor or moderate injury.
- WARNING:** **WARNING** indicates a hazard that may result in moderate or serious injury.
- [Start]-[Shut Down]: This illustration means to click [Start], then to click [Shut Down].
(For some applications, you may need to double-click.)
- Enter** : This illustration means to press the [Enter] key.
- Ctrl** + **ESC** : This illustration means to press and hold the [Ctrl] key, then press the [ESC] key.
- : Where to go for referred information.
- Some of the illustrations in this manual may differ slightly in shape from the actual items in order to make the explanation easier to understand.

Copyright

This manual is copyrighted by Matsushita Electric Industrial Co., Ltd. with all rights reserved. No part of this manual may be reproduced in any form without the prior written permission of Matsushita Electric Industrial Co., Ltd.

No patent liability is assumed with respect to the use of the information contained herein.

© 2000 Matsushita Electric Industrial Co., Ltd. All Rights Reserved.

Disclaimer

Computer specifications and manuals are subject to change without notice. Matsushita Electric Industrial Co., Ltd. assumes no liability for damage incurred directly or indirectly from errors, omissions or discrepancies between the computer and the manuals.

Trademarks

Microsoft, MS-DOS and Windows are registered trademarks of Microsoft Corporation of the United States and/or other countries.

Celeron™ is a trademark of Intel Corporation.

Adobe Acrobat and Adobe Premiere are registered trademarks of Adobe Systems Incorporated.

Dolby is a trademark of Dolby Laboratories.

WinDVD™2000 is a trademark of InterVideo, Inc.

Panasonic is a registered trademark of Matsushita Electric Industrial Co., Ltd.

Read Me First

For U.S.A.

Federal Communications Commission Radio Frequency Interference Statement

Note: This equipment has been tested and found to comply with the limits for a Class B digital device, pursuant to Part 15 of the FCC Rules. These limits are designed to provide reasonable protection against harmful interference in a residential installation. This equipment generates, uses and can radiate radio frequency energy and, if not installed and used in accordance with the instructions may cause harmful interference to radio communications. However, there is no guarantee that interference will not occur in a particular installation. If this equipment does cause harmful interference to radio or television reception, which can be determined by turning the equipment off and on, the user is encouraged to try to correct the interference by one or more of the following measures:

- Reorient or relocate the receiving antenna.
- Increase the separation between the equipment and receiver.
- Connect the equipment into an outlet on a circuit different from that to which the receiver is connected.
- Consult the Panasonic Service Center or an experienced radio/TV technician for help.

Warning

To assure continued compliance, use only shielded interface cables when connecting to a computer or peripheral. Also, any changes or modifications not expressly approved by the party responsible for compliance could void the user's authority to operate this equipment.

This device complies with Part 15 of the FCC Rules. Operation is subject to the following two conditions:

- (1) This device may not cause harmful interference, and
- (2) This device must accept any interference received, including interference that may cause undesired operation.

Responsible Party:

Panasonic Consumer Electronics Company
Division of Matsushita Electric Corporation of America
One Panasonic Way
Secaucus, NJ 07094
Tel No: 1-800-272-7033

FCC Regulation Notice for modem

1. This equipment complies with Part 68 of the FCC rules. On the computer is a label that contains, among other information, the FCC registration number and ringer equivalence number (REN) for this equipment. If required, this information must be provided to the telephone company.

2. An FCC compliant telephone cord and modular plug is provided with this equipment. This equipment is designed to be connected to the telephone network or premises wiring using a compatible modular jack which is Part 68 compliant. See Installation Instructions for details.
3. The REN is used to determine the quantity of devices which may be connected to the telephone line. Excessive RENs on the telephone line may result in the devices not ringing in response to an incoming call. In most, but not all area, the sum of RENs should not exceed five (5.0). To be certain of the number of devices that may be connected to a line, as determined by the total RENs, contact the local telephone company.
4. If your telephone equipment cause harm to the telephone network, the telephone company will notify you in advance that temporary discontinuance of service may be required. But if advance notice isn't practical, the telephone company will notify the customer as soon as possible. Also, you will be advised of your right to file a complaint with the FCC if you believe it is necessary.
5. The telephone company may take changes in its facilities, equipment, operations or procedures that could affect the operation of the equipment. If this happens the telephone company will provide advance notice in order for you to make necessary modifications to maintain uninterrupted service.
6. If trouble is experienced with this equipment, for repair or warranty information, please contact Matsushita Electric Corporation of America, toll free at 1-800-272-7033. If the equipment is causing harm to the telephone network, the telephone company may request that you disconnect the equipment until the problem is resolved.
7. There are no user serviceable parts contained in this equipment.
8. This equipment may not be used on coin service provided by the telephone company. Connection to party lines is subject to state tariffs.
9. The Telephone Consumer Protection Act of 1991 makes it unlawful for any person to use a computer or other electronic device to send any message via a telephone fax machine unless such message clearly contains in a margin at the top or bottom of each transmitted page or on the first page of the transmission, the date and time it is sent and an identification of the business or other entity, or other individual sending the message and the telephone number of the sending machine or such business, other entity, or individual. In order to program this information into your fax software, you should refer to the manual of the Fax software being used.
10. According to the FCC's electrical safety advisory, we recommend that you may install an AC surge arrestor in the AC outlet to which this equipment is connected. Telephone companies report that electrical surges, typically lightning transients, are very destructive to customer terminal equipment connected to AC power sources and that this is a major nationwide problem.

"Caution : To reduce the risk of fire, use only No.26 AWG or larger telecommunication line cord."

"ATTENTION : Pour réduire le risque d'incendie, utiliser uniquement des conducteurs de télécommunications 26 AWG ou de section supérieure."

Read Me First

Getting Started

Important Safety Instructions

When using your telephone equipment, basic safety precautions should always be followed to reduce the risk of fire, electric shock and injury to persons, including the following:

1. Do not use this product near water, for example, near a bath tub, wash bowl, kitchen sink or laundry tub, in a wet basement or near a swimming pool.
2. Avoid using a telephone (other than a cordless type) during an electrical storm. There may be a remote risk of electric shock from lightning.
3. Do not use the telephone to report a gas leak in the vicinity of the leak.
4. Use only the power cord and batteries indicated in this manual. Do not dispose of batteries in a fire. They may explode. Check with local codes for possible special dispose instructions.

SAVE THESE INSTRUCTIONS

Lithium Battery

Lithium Battery!

This computer contains a lithium battery to enable the date, time, and other data to be stored. The battery should only be exchanged by authorized service personnel.

Warning! A risk of explosion from incorrect installation or misapplication can possibly occur.

DVD-ROM Drive Caution

CAUTION!

THIS PRODUCT UTILIZES A LASER.

USE OF CONTROLS, ADJUSTMENTS OR PERFORMANCE OF PROCEDURES OTHER THAN THOSE SPECIFIED HEREIN MAY RESULT IN HAZARDOUS RADIATION EXPOSURE.

DO NOT OPEN COVERS AND DO NOT REPAIR YOURSELF.

REFER SERVICING TO QUALIFIED PERSONNEL

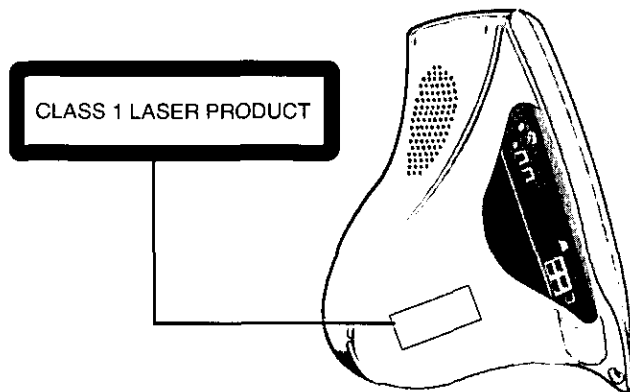

Precautions

● Usage

Avoid Extreme Heat and Cold

Do not store or use the computer in locations exposed to heat, direct sunlight, or extreme cold.

Avoid moving the computer between locations with large temperature differences.

Operation: 5 °C to 35 °C {41 °F to 95 °F}

Storage: -20 °C to 60 °C {-4 °F to 140 °F}



Avoid Direct Sunlight on the LCD Display

The LCD display should not be exposed to direct sunlight or ultraviolet light.



Avoid Humidity, Liquids, and Dust

Do not store or use the computer in locations exposed to high humidity, liquids (including rain) or dust.



Prevent Shock

Avoid subjecting the computer to severe vibrations or impact. Do not place the computer inside a car trunk.

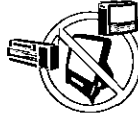

Avoid Radio Frequency Interference

Do not place the computer near a television or radio receiver.

● Handling



Avoid Magnetic Fields

Keep the computer away from magnets.



Avoid Stacking

Do not place heavy objects on top of the computer.



Keep Small Objects Away

Do not insert paper clips or other small objects into the computer.

About the Display

The display is weak against force or vibration and can easily break, so take the necessary precautions when setting or moving the display.

When moving the computer

When moving the computer, position yourself in front of the computer and get a firm grip of the base to move the computer. Do not grab the periphery of the display or carry the computer by the stand.

Saving Data on the Hard Disk

- **Do not expose your computer to shock.**
Use care when handling your computer, shock may damage your hard disk or make your software applications and data unusable.
- **Do not power off your computer while software applications are running or HDD indicator (HDD) is on.**
Properly shut Windows down to avoid problems ([Start] - [Shut Down]).
- **Save all valuable data to floppy disks.**
Backing up data to floppy disks will limit damage should trouble occur to your computer or should you inadvertently change or erase data.
- **Use the security function for all important data.** (☞ page 50)

Saving Data on Floppy Disks

- **Do not power off your computer or press the floppy disk drive eject button while the indicator is on.**
Doing so may damage the data on the floppy disk and render the disk useless.
- **Use care when handling floppy disks.**
To protect the data on your floppy disks or to prevent a floppy disk from becoming stuck in your computer, avoid the following:
 - Sliding the shutter on the floppy disk manually.
 - Exposing the disk to a magnetic field.
 - Storing the disk in locations prone to high temperatures, low pitched noise, dampness, or dust.
 - Applying more than one label on the disk.
- **Confirm the contents of a floppy disk before formatting it.**
Confirm that no important data is on the disk, because all data on the disk will be erased.
- **Use the write-protect tab.**
This is a must for preserving important data. This prevents your data from being erased or overwritten.



Write Enable

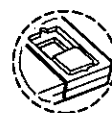

Write Disable

Computer Viruses

- **Users are advised to purchase the latest versions of virus protection software and use them regularly.**

We recommend you run the software:

- When booting your computer.
- After receiving data.

We recommend that you check data received on floppy disks or from external sources, such as data downloaded from the Internet, e-mail, etc. (For compressed files, please uncompress them before running a check).

Restrictions when starting a program in the MS-DOS mode

The MS-DOS mode has the following restrictions.

- The floppy disk drive cannot be used.
- The system may freeze when a large amount of characters are input from the keyboard at one time.

Maintenance

Areas Excluding the Display

Wipe these areas with a soft cloth, after applying water or detergent diluted with water to the soft cloth and firmly wringing out excess water.

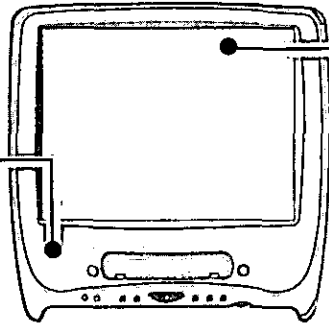

LCD Display

Avoid using water when cleaning the panel. Ingredients included in water may leave residue and reduce readability of the screen.

<When cleaning dust/dirt>

Avoid rubbing off dust/dirt with a cloth since it may scratch the screen.

Sweep dust/dirt with fine brush, then wipe it with "dry" soft cloth used for cleaning glasses.

<When cleaning oily surface>

Apply camera lens cleaner on a soft gauze and clean it with gentle force. Then, wipe with a dry soft cloth used for cleaning glasses.

CAUTION

- Do not use benzene, thinner, or rubbing alcohol. Doing so may adversely affect the surface, e.g., discoloration. In addition, do not use commercially-available cleaners and cosmetics, as they may contain components harmful to the surface.
- Do not directly add or spray water or detergent. If liquid enters the inside of the computer, it may cause it to work improperly or be damaged.

About System File Checker

Microsoft Corporation has announced that, with a computer in which Internet Explorer 5.01 is installed, if the [System File Checker] in [System Information] is executed, the following may occur.

- The message [System File Checker identified that the following file may be corrupted] may appear for a normal file.
- In such cases, there is the possibility that the system will become unstable if the file is repaired with the System File Checker.

In this computer, since Internet Explorer 5.01 is the default browser, we recommend not using the System File Checker.

Names and Functions of Parts

Front

LCD Display

This display provides clear and vibrant images close to those of a TV set with our LCD high image quality signal processing technology (Bright LCD).

Internal Microphone

(☞ page 32)

DVD-ROM Drive

(☞ page 24)

Recessed Manual Disc Eject Button

(☞ page 25)

Speaker

Speaker

Sleep Switch

Pressing this switch, the computer will be shut down by using the hibernation function. (☞ page 18)

Eject Button

Display Brightness Control

Darker Lighter

Power Indicator

Green: Power ON

Mail Button

Press this button to start Outlook Express. (It is necessary to make settings to connect network services like the internet and to use e-mail beforehand.)

Power Switch

DVD-ROM Drive Indicator

This indicator lights when DVD-ROM drive is accessed.

Volume Adjustment Buttons

△ Right :Up

▽ Left :Down

Pressing both buttons simultaneously activates the mute mode. To generate sound once again, press either of the two buttons.

HDD Indicator

This indicator lights when the hard disk drive is accessed.

Headphone Jack

Use this jack to connect headphones or amplifier-equipped speakers. Audio output from the internal speaker is disabled when headphones or external speakers are connected.

Microphone Jack

Use this jack to connect a monaural condenser microphone (miniature jack).

Left Side

Reset Button

When resetting your computer, use a dull pointed object. Do not use a pencil. Pencil lead can break off inside and damage the computer.

CAUTION

If a problem occurs but your computer does not lock, we recommend not pressing the reset button. It will cause you to lose data if an application is open.

RAM Module Slot

(☞ page 33)

IEEE1394 Interface Connectors

iS400

Connect to devices under the IEEE1394 standards, such as a DV deck or digital video camcorder.

PC Card Slot

Use the PC Cards that conform to the PC Card Standard.
(☞ page 31)

PC Card Eject Button

(☞ page 31)

USB Ports



Connect to various peripheral devices (e.g., printers and a floppy disk drive) that are USB compatible even with the computer on (☞ page 28). It may be necessary to install a driver program for a USB device; the driver program will be included with the device. Be sure to read the instructions manual provided with the USB device.

NOTE

Driver programs do not need to be installed for the mouse, keyboard and floppy disk drive provided with this computer.

Optical Digital Audio Output Terminal

Outputs to a player such as an MD deck with an optical input terminal, without any noticeable degradation in the digital sound quality of CDs and DVD.
(☞ page 32)

NOTE

Removing the dust protection cap for the Optical Digital Audio Output Terminal

After removing the dust protection cap, store the removed cap in safe place. When the terminal is not being used, be sure that the cap is covering the terminal.

Dust Protection Cap

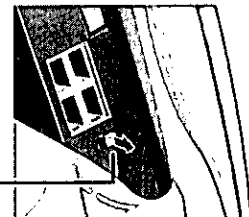

Names and Functions of Parts

Getting Started

Right/Rear/Bottom Side

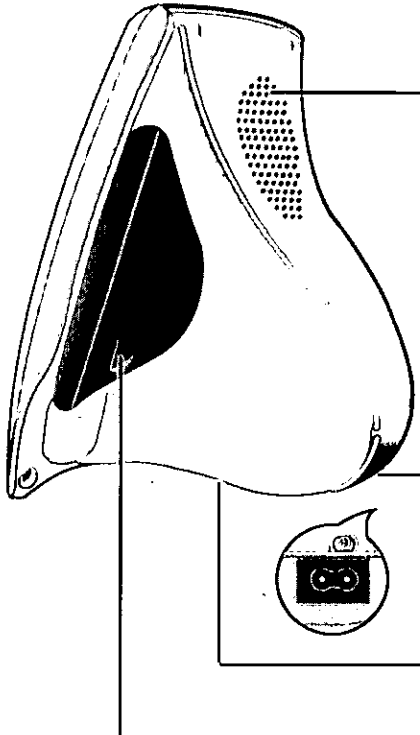

Ventilation Hole

These holes allow heat to exit.

CAUTION

Do not block or place the computer in a location that may prevent proper ventilation.

Power Terminal Connector

Connects to the AC cord provided with the computer. Before using the computer for the first time, carefully read the [LIMITED USE LICENSE AGREEMENT](☞ page 59). If you agree to the conditions, remove the seal.

Stand (Located at the bottom)

By placing the display on the stand, two types of angle settings can be made.

Internal Modem

Connects to a telephone outlet with the included modem telephone cable.

Keyboard

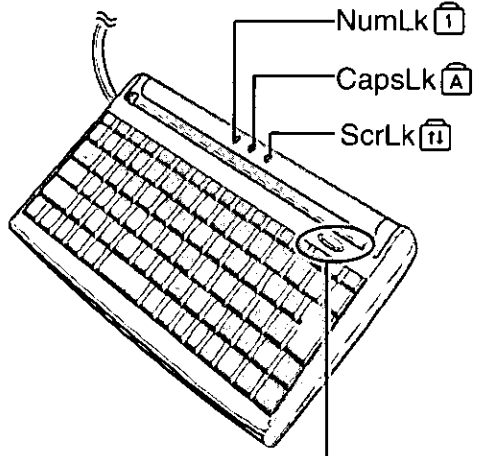

"TILT UP" Button
Pressing this button, the stand can be rotated and the keyboard can be raised.









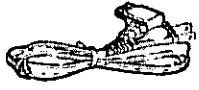

<p>NumLk (Numeric key)</p>	<p>This indicator lights green when NumLk is pressed. This causes a portion of the keyboard to function as a numeric keypad. The Numeric key functions differently depending on the application. To switch it OFF, press NumLk again.</p>
<p>Caps Lock</p>	<p>This indicator lights green when Caps Lock is pressed. Subsequent non-shifted input is capitalized. To switch it OFF, press Caps Lock again.</p>
<p>ScrLk (Scroll lock)</p>	<p>This indicator lights green when ScrLk is pressed. Scroll lock functions differently depending on the application. To switch it OFF, press ScrLk again.</p>

First-time Operation

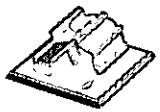
Read the steps below to help you learn what parts are included, and to gain an understanding of some basic computer-related operations.

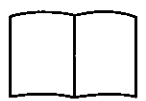
1 Confirm the inclusion of all parts

Make sure the parts shown in the figure have been supplied. If any of these items are missing or is not working properly, contact Panasonic at 1-800-272-7033.

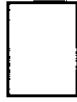
Keyboard 1		Mouse 1	
			
Floppy Disk Drive 1	AC Cord 1	Modem Telephone Cable .. 1	
			
Clamper 1	Eject Pin 1	Operating Instructions 1	
			
Product Recovery CD-ROM 1		Windows® Book 1	
			
WinDVD™2000 CD-ROM 1		Sheet For WinDVD™2000 1	
			

NOTE

How to use the clamper

You can choose to bundle the connection cables.

- ① Set the clamper at the position shown in the figure and put the cables in the clamper.
- ② Mount this part into the groove.

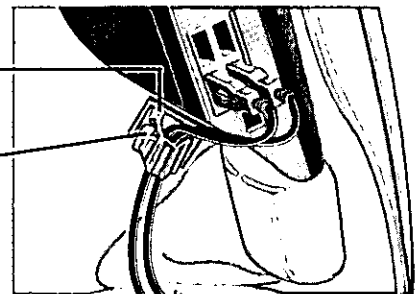

Use care in maintaining the items included with your computer

Handle the Product Recovery CD-ROM with care. You may need to use this CD-ROM if reinstallation becomes necessary.

First-time Operation

2 Write Down the Product Key Code

CAUTION

The Product Key Code is necessary to perform the setup procedure for Windows (☞ page 14) after reinstallation (☞ page 57). Write down the alphanumeric Product Key Code shown on the "Certificate of Authenticity" located on the right side of the computer in the "Customer's Record" section (☞ page 2).

3 Connect the keyboard and mouse to the USB ports.

The keyboard and mouse can each be connected to any one of the four ports. USB compliant devices such as a floppy disk drive and printer can be connected to the remaining two ports (☞ page 28).

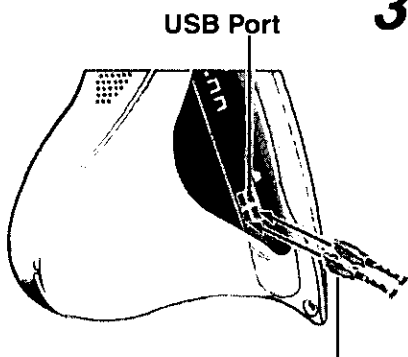

Be sure the  mark is facing towards the back of the computer.

NOTE

Two Ways of Positioning the Computer (Display)

● When using the stand

Completely set in place (open)



● When not using the stand

The display is slightly tilted upwards.

Completely set in place (closed)

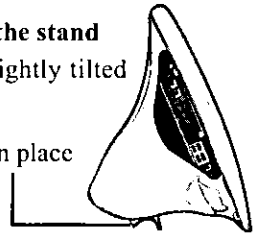

Set the stand after powering OFF. Do not use the computer if the stand has not been set in place completely.

CAUTION

When connecting peripherals other than the keyboard and mouse, connect them after completing the setup procedure on page 14.

4 Read the LIMITED USE LICENSE AGREEMENT (☞ page 59)

Before removing the seal covering the power terminal connector, read the LIMITED USE LICENSE AGREEMENT. Removal of this seal indicates agreement to the terms specified.

5 Connect the AC cord

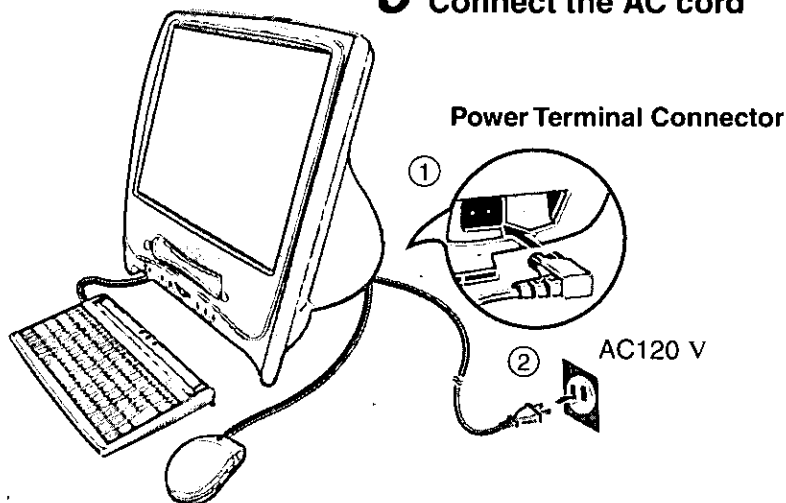

6 Set the stand for the keyboard

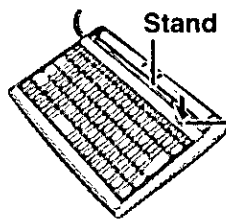

When the "TILT UP" button is pressed, the stand can be rotated and the keyboard can be raised.

NOTE

When the keyboard is not in use

- ① Hold both ends of the keyboard and rotate the stand to its original position.
- ② Slide the keyboard under the computer.

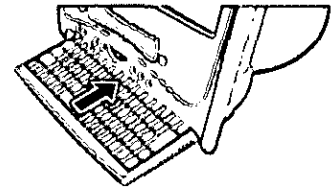
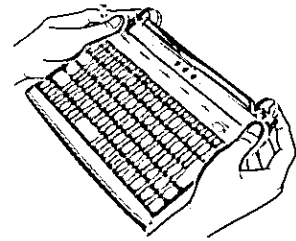

7 Turn your computer on

Press the power switch and hold it for approximately one second until the power indicator (Ⓛ) turns on before releasing it.

CAUTION

After confirming that the power indicator has turned on, do not touch the power switch until Windows setup has started.

NOTE

When the display becomes black (i.e., goes OFF) during operation

The power management function is set at the factory, and therefore, if the computer is not used for about 15 minutes, it automatically darkens the display of the screen and controls the consumption of power. If either a key is pressed or the mouse is moved, the original screen will reappear. Do not leave your computer during the setup procedure to prevent accidents such as another person pulling out the AC cord.

If you leave the computer, the power to the LCD may be turned off while Windows is setting up or even when an application software is being installed. In this case, because it is conceivable that a selection dialog box will be shown, do not press the **Enter** key to attempt to resume from this condition as doing so may trigger a selection, but instead, press a key unrelated to the direct triggering of a selection, like the **Ctrl** key.

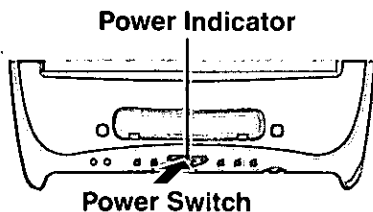

First-time Operation

8 Setup Windows 98

- ① Select settings for your region and your keyboard layout, then press [Next].
(for U.S.A.: United States 101)

NOTE

Moving the cursor (↔) or clicking buttons can be performed with the mouse.
(☞ page 15)

If you accidentally click [Next] and continue on to the next screen

Simply set the arrow on [Return] and click on the mouse. You will return to the previous screen.

- ② Enter your name, then press [Next].
- ③ Select [Skip] at the [Using Your Modem to Connect].
- ④ Select [Yes] at the [Cancel Dialing], then press [Next].
The License Agreement will be displayed.
- ⑤ After reading the agreement, select [I accept this agreement] or [I do not accept the agreement], then press [Next].

NOTE

- If [I do not accept the agreement] is selected, the Windows setup will be aborted.
- **<During the setup procedure for reinstalling only>**
After accepting the agreement, the [Windows Product Key Code] is displayed. Input the Product Key Code written down in the "Customer's Record" section, then press [Next]. (☞ page 12 step 2)

- ⑥ Press [Finish].
- ⑦ Input the correct date, time and time zone and press [Close].
You can also complete these settings at a later time.



9 Computer power off

Please refer to page 17 for powering off the computer.

Using the Mouse

Use the mouse to move the cursor on the display and perform normal computer operations.

Basic Operation

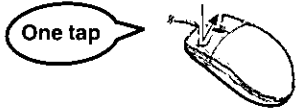
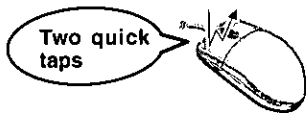
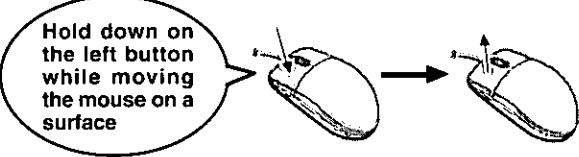

Function	Operation
Moving the Cursor 	When you lightly grasp the mouse and move (i.e., slide) it, the arrow on the screen will move together with the movement of the mouse. If there is no longer any space for moving the mouse, lift the mouse and set it at a suitable location, and then continue moving the mouse. 
Clicking To select an item, etc.	
Double-Clicking To execute an item, etc.	
Dragging To move item. To draw lines with a Paint, etc.	

How to advance (scroll button)

When reading a large document like a home page, it is possible for you to read hidden parts out of the screen (i.e., scroll), and magnify or reduce the display.

NOTE

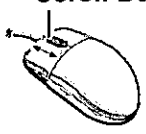
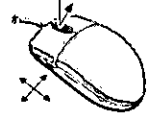
- The scroll function may not work depending on the software application.
- The scroll function works when the scroll bar is displayed.

Function	Operation
Scroll Scroll a document up and down.	Slide the scroll button forward or backward. (Maintaining the sliding enables continuous scrolling.) 
Auto-scroll Scroll a document up and down or left and right.	<ol style="list-style-type: none"> ① Click the scroll button, and ② Move the mouse. Scrolling is performed at the speed of the mouse.  <ul style="list-style-type: none"> ● To cancel the auto scroll function, move the arrow to a blank area on the screen and click the scroll button.
Zoom Magnify or reduce the display of a document.	Slide the scroll button forward (i.e., zoom in) or backward (i.e., zoom out) while pressing down on Ctrl . 

Starting Up/Shutting Down

Starting Up

Here, an explanation is given on how to turn the computer on after completing the setup procedure of Windows. If peripherals like a printer are connected, there is an order to follow to turn the power on. (Windows setup  page 14)

1 When peripheral devices (e.g., Printer) are connected, turn on the power of each of these devices first

About peripheral devices, be sure to read the instructions manual provided with each of the peripheral devices.

2 Turn your computer on

Press the power switch and hold it for approximately one second until the power indicator turns on before releasing it.

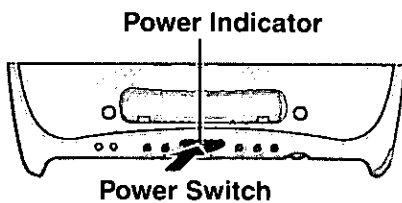

CAUTION

After confirming that the power indicator has turned on, avoid the following until Windows has completed loading.

- Touching the power switch.
- Performing any keyboard or mouse operations.

● If the message "Enter your Password" is displayed, you must first enter your password. (page 50)

Upon entering your password and pressing **Enter**.

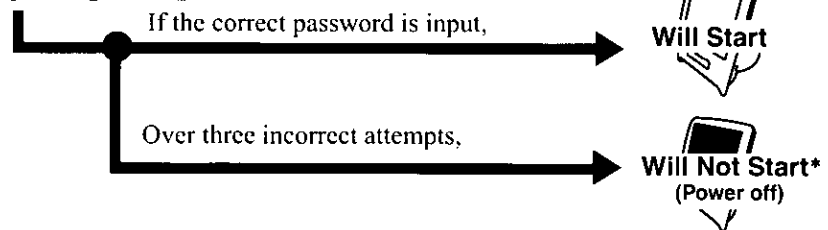

* If you are starting from the hibernation mode ( page 18), if you fail to enter correct password three times, or if no password is entered for about a minute, the computer returns to the hibernation mode.

● When an application or file that was previously displayed appears on your screen,

The computer has been shut down by using the hibernation function. ( page 18)

NOTE

- The power saving mode ([Power Schemes] in [Control Panel] - [Power Management]) is factory set, so if there is no input from a key or a mouse for a certain interval of time, the power to the LCD and hard disk may be turned off. The LCD will resume operation when a mouse is used or a key is pressed.
- [System devices] in [Start] - [Settings] - [Control Panel] - [System] - [Device Manager] may contain a device or devices bearing an exclamation mark or question mark. This does not indicate a malfunction. Such a mark (exclamation or question mark) will not be displayed if the operating environment of the device showing the mark is corrected, by for instance installing the driver of the device.

Shutting Down (power off your computer)

When the power switch is pressed, the "Power Button Control Program" activates, automatically performs the Windows shutdown processing, and powers the computer off. If a software application is open, power off the computer after saving the data and closing the application software.

1 Confirm that  is displayed on the taskbar

2 Turn your computer off

Press the power switch and hold it for approximately one second until the power indicator turns off before releasing it.

Your computer will power off automatically (without using the hibernation function). (In the OFF state, your computer consumes approximately 1.2 W.)



CAUTION

Once the computer is powered off, you must wait at least ten seconds before powering it on again.

NOTE

About the Power Button Control Program



On the next occasion, do not press the power switch (if the power switch is pressed, this will force the computer to shut down). Perform the "shutdown operation of Windows" (below).

- When  is not displayed on the taskbar (the Power Button Control Program is off)
( of the Power Button Control Program is displayed when the computer is started up again.)
- When the display has gone off due to the Power Management Function



When is not displayed (shutdown operation of Windows)

Perform the "Shutdown Windows" operation as follows. If the "Shutdown Windows" operation does not proceed correctly, this may be due to a problem in the computer or the deletion of system data.

① Click [Start]-[Shut Down].

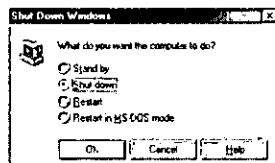
(From the keyboard, you may choose to press down on  , then select [Shut Down] with  or .)



② Confirm that  is on the left side of "Shut down", and then click [OK].
If  is not on the left side of "Shut down", click the characters of "Shut down" or move the arrow over  and click the mouse.

Starting Up / Shutting Down

Starting Up Your Computer Quickly

If the computer is powered off while system standby (hereafter, hibernation) function is being used, the state of the computer is saved to the hard disk and then the power goes off. When the power is turned back on again, the original state before the computer went off is called up, allowing you to immediately continue unfinished work.

The following methods are available to enter the hibernation mode.

- Enter the hibernation mode with the sleep switch
- Enter the hibernation mode by selecting [Stand by]

CAUTION

- Save your data before using the hibernation function for safety.
- For the purpose of refreshing your computer, periodically (i.e., about one time a week) perform the "Windows Shutdown" operation and power your computer off without using the hibernation function.

Enter the Hibernation Mode With the Sleep Switch

Sleep Switch

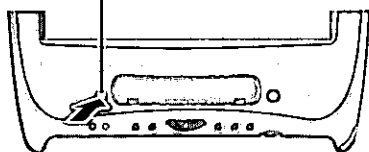

1 Press the sleep switch

Confirm that there is a beep sound and take your hand away. If the volume level is set to low, the sound will be inaudible.

CAUTION

Do not press down on the sleep switch for four seconds or more. If the switch is held down for this period of time, a continuous beeping sound continues, and the computer is forced to shut down without entering the hibernation mode.

When the screen goes off after a short period of time, the current state of the computer is saved to the hard disk. While data is being saved, the screen becomes blue and a red indicator is displayed showing the progress of the process. After that, the power of the computer goes off. (The power indicator goes off.)

Enter the Hibernation Mode By Selecting [Stand by]

1 Select [Start] - [Shut Down]

2 Select [Stand by]

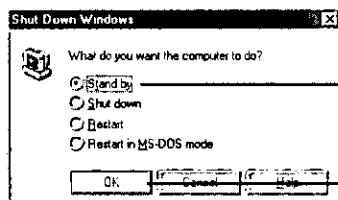

① Click [Stand by]

② Click [OK]

After the screen goes off after a short period of time, the current state of the computer is saved to the hard disk. While data is being saved, the screen becomes blue and a red indicator is displayed showing the progress of the process. After that, the power of the computer goes off. (The power indicator goes off.)

Resuming From the Hibernation Mode

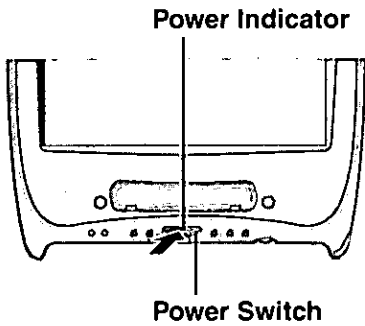

Press the power switch and hold it for approximately one second until the power indicator turns on before releasing it.

The power indicator lamp lights green and the display returns to the state before the power was cut (i.e., resume).

CAUTION

- Be sure not to use the keyboard or mouse while data is being read from the hard disk.
- If the computer enters hibernation mode and resumes under the condition that an external drive (such as a hard disk drive or PD drive that uses a PC Card) is connected, the number of windows of the connected drive may increase.

NOTE

Do not enter the hibernation mode for the following cases.

There are cases where the following functions or peripheral devices do not operate properly.

- While communications software is running
- While audio media is being played or recorded
- While moving images are being played or captured (i.e., saved).
- While a peripheral device like a PC Card (SCSI or ATA card) is being used.
- While a floppy disk drive or the hard disk drive is being used.
- While a DVD-ROM drive or USB device (excluding the keyboard and mouse provided with this computer) is being used.
- When a file in an external drive connected to the USB port is used.

What not to do when the computer is entering the hibernation mode or resuming

- When the computer is entering the hibernation mode, do not press the reset switch. Data that had not been saved will be lost.
- When resuming, do not operate the mouse or keyboard until Windows completely starts up.

Unable to enter the hibernation mode

- With an operating system (OS) other than Windows, the power of the display may not resume properly or the computer may be unable to enter the hibernation mode.
- The computer may be unable to enter the hibernation mode when there is software residing in memory.

Terminology

Resume:

To return to the original state when the computer is turned on again from the hibernation mode.

Resident software (resident programs):

Software that works while normally maintained in memory (or, is able to work at any time).

Conserving Power

When your computer is left alone for a while, you can set it to automatically enter the system standby (hereafter, hibernation mode) or cut the power of the display.

Setting Power Management

1 Select [Start]-[Settings]-[Control Panel]-[Power Management]

2 Select [Power Schemes]

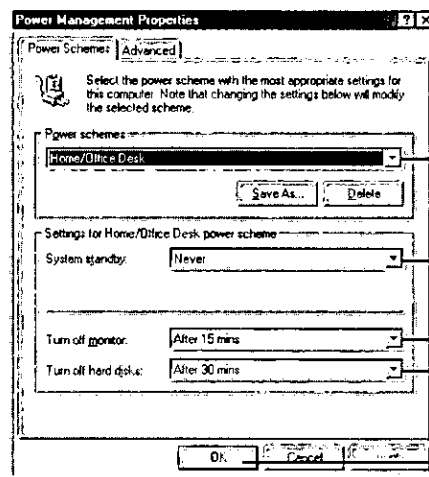

① Click and select the setting

② Click and set the time for each

③ Click [OK]

NOTE

Power schemes

Select one from among:
[Home/Office Desk]
[Portable/Laptop]
[Always On]

System standby

This function allows your computer to enter the hibernation mode (☞ page 18), if it is not being used, after the amount of time set has elapsed.

Turn off monitor

This function cuts the power of the display, if the computer is not being used, after the amount of time set has elapsed. (The power indicator lamp remains lit.)

Turn off hard disks

This function cuts the power of the hard disk, if the computer is not being used, after the amount of time set has elapsed.

The initial values for the power source settings following a change to [Portable/Laptop] or [Always On] are given in the table below.

Item	Portable/Laptop	Always On
System standby	After 20 minutes	Never
Turn off monitor	After 15 minutes	After 15 minutes
Turn off hard disks	After 30 minutes	After 1 hour

NOTE

When “Turn off monitor” is set,

Do not set the screensaver. When both this function and the screensaver are set, the power of the display may not respond properly or the computer may be unable to properly resume from the hibernation mode.

When the communications function is utilized,

When communications is being performed using a modem, the power saving function activates and the computer may enter the hibernation mode during data communications or the communications may not proceed smoothly. When using the communications function, we recommend setting [Never] for [System standby] or setting a sufficiently long period of time in the dialog box.

If the Power Saving Function Activates

If the computer is left alone for the time set on the previous page, the power saving function will activate.

● **If the computer screen turns off**

Either press a key or move the mouse to resume.

At this time, use a key that will have no influence on software in the computer (e.g., **Ctrl**), since the input of the keyboard or mouse is received by the computer.

● **When the screen does not return to the original screen even with the above operation**

The system standby is activated and the computer has entered the hibernation mode.

Power on the computer by holding the power switch down for approximately one second.

Refer to the page 19 for the details on resuming operation from the hibernation mode.

NOTE

When the power of the hard disk has been cut

The power of the hard disk is automatically turned back on when an attempt is made to access the hard disk.

Setting the Sound Volume

The following settings can be made for the audio output on the computer.

Using the Audio Mixer

Use the Mixer applet to control the overall sound level as well as the volume of the internal and external sound sources.

1 Select from the taskbar

The volume control

Drag the slide bar to adjust the level.

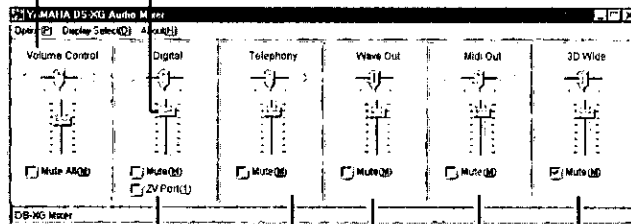

Click to close the "DS-XG Audio Mixer".

Sounds from an audio CD

Sounds from a modem

Sounds from a video CD or DVD

The effective sounds of Windows (e.g., sounds at start-up)

MIDI (e.g., Game)

Sets 3D output (about 360 degrees) sounds when speakers or headphones are connected.

• Volume control

This control adjusts the sound volume regardless of the sound source. The control corresponds to the sound volume adjustment buttons of the computer (page 8). In addition, the volume control itself can be displayed by clicking  on the taskbar.

• Mute

If a checkmark is added to [Mute], the computer outputs no sound.

NOTE

When the input level in the camera mode from a microphone or CD is low

- 1 Click [Option] - [Option] in the [Audio mixer] screen.
- 2 Select [Recording] in [Adjust volume for], and then select [Microphone] or [Digital] (for an audio CD) in [Show the following volume controls]. (Confirm that there is a checkmark.)
- 3 After clicking [OK], drag the slide bar to adjust the sound level.

About Microphone Howling (Feedback)

Feedback, a high-pitched whistle or howling, may occur under some circumstances when the volume of the microphone is set too high, when the microphone is too close to the speakers, when you are too close to the microphone, or when you place your hand over or around the microphone. In such cases, click [Option] - [Option] in the [Audio mixer] screen, select [Playback] in [Adjust volume for], add a checkmark to [Microphone] in [Show the following volume controls], click [OK], and mute the [Microphone].

Or, adjust the volume levels of the microphone and speaker to a suitable degree so that howling no longer occurs.

Making Settings In the Control Panel

1 Select [Start] - [Settings] - [Control Panel]

2 Select [YAMAHA DS-XG Audio Config]

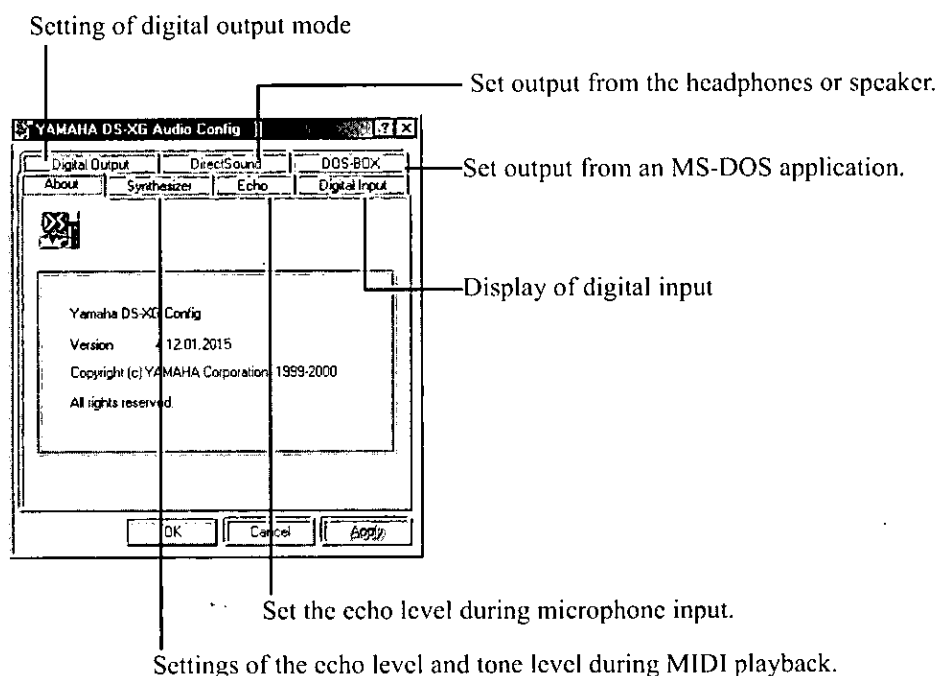

NOTE

Refer to the instructions on the settings by clicking the item after clicking the  button in the display.

3 After setting each item, click [OK]

CAUTION

About digital output

- You must adjust the sound level on a peripheral device (➤ page 32) when connecting to the optical digital audio output on the computer.
- If a check mark is added to the [Mute All] in [YAMAHA DS-XG Audio Mixer] - [Volume Control], the digital audio output will also be muted. If no sound is audible from the digital audio output even if the check mark is removed from [Mute All], increase the [Volume Control] level. (Adjust the sound volume on the peripheral device.)

[Dolby Digital] playback of a DVD video disc

- When a peripheral device is not compatible with [Dolby Digital] output, the disc will not be played correctly. In addition, there are cases in which large sounds are output at the same time as the playback of the sound source. Reduce the sound volume of the peripheral device.
- When no sound is output from the optical digital audio output terminal, click the [Digital Output] tab, then confirm that  is not on the left side of [OFF] or [ON (Direct)]. (Confirm the sound level of the peripheral device beforehand.)
- Confirm that the sound setting in the application software is correct.

DVD-ROM Drive

The DVD-ROM drive is a device that can read the data from both CD and DVD discs. When you place a disc in the drive the computer will determine the type of data that is on the disc and load the appropriate application to run, play, or view the program material on the disc.

Usage Precaution

- Do not place items other than discs in the tray.
- **Do not leave the tray in the open position.**
- Under some conditions, dust may build up on the disc, possibly resulting in malfunction.
- Do not apply excessive force to the tray in the open position, doing so could damage the tray.
- Do not open the DVD-ROM drive while the DVD-ROM drive is being accessed. Doing so could cause it to malfunction. In addition, after running an application involving access to a disc, do not open the DVD-ROM drive or remove the disc until after the application has been closed.
- After closing the tray, do not attempt to access a disc until the DVD-ROM drive indicator (Ⓢ) disappears.
- Never insert foreign objects such as paper clips into the slot in the DVD-ROM drive.
- Do not use discs that have become deformed (warped, not completely round, etc.).

To avoid damaging discs:

- Do not touch the surface as it can cause the disc to become dirty or scratched.
- Do not allow discs to become dirty or scratched.
- Do not place or store discs in locations exposed to heat, direct sunlight, humidity or dust.
- Do not write on the surface of the disc with a ball-point pen or other writing instrument.
- If the disc is brought from a cold into a warm environment, moisture may form on the disc. Wipe this moisture off with a soft, dry, lint-free cloth before using the disc.
- Do not drop, bend, or place heavy objects on top of discs.
- Cleaning the disc using a CD cleaner is recommended once every 2 or 3 months.

If the disc gets dirty



After wiping the disc with a moist, soft cloth, wipe it with a dry cloth. Always wipe from the center toward the edge.

Using the DVD-ROM Drive

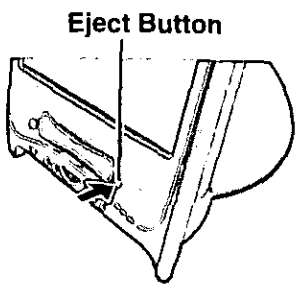

- 1 Confirm the computer is powered on, press the eject button lightly

NOTE

To remove a disc when the computer is powered off or when the tray cannot be pulled out, insert the eject pin (included with the computer) into the recessed manual disc eject button and push it completely to the end.

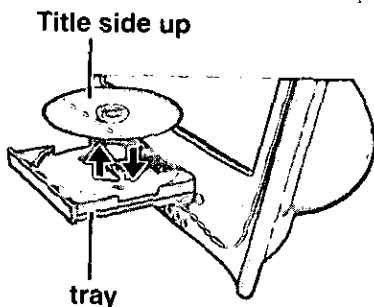

- 2 Place a disc / Remove a disc

- 3 Close the disc tray by pressing the eject button

CAUTION

- The regional code of the DVD-ROM drive of the computer is set to [1]. If the regional code of the DVD-ROM drive is changed by using a software application for DVD playback (ex. WinDVD™ 2000), DVD software set for region [1] will no longer be able to be played.
- The region settings can be changed for up to 4 times. After the fourth change is made, it will no longer be possible either to change the setting or to return to the original setting.

Modem

Connecting to a Telephone Line and Settings

1 Connecting a telephone line to the internal modem

It is not possible to connect the internal modem to any of the following lines.

- Internal home phones
- Intercoms

CAUTION

The internal modem is designed for use with a standard telephone line. Connecting the modem to a Digital PBX, Intercom, or internal home phones may cause damage that is not covered under warranty.

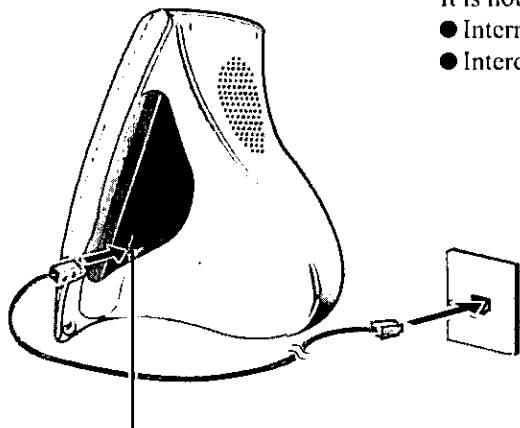

Internal Modem

2 Select [Dialing Properties] in [Start] - [Settings] - [Control Panel] - [Modems]

Input the necessary information (items such as the phone system) and then press [OK].

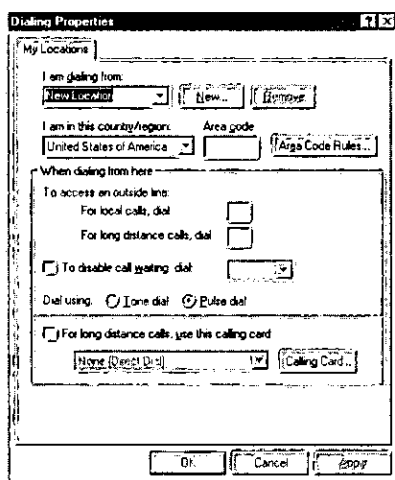

Be sure to make the [Dial-Up Networking] settings in [My Computer] and [Outlook Express] before connecting to network services like the Internet or when using e-mail.

CAUTION

Do not put a check mark in the redial check box for Dial-Up Networking. Automatic redialing to any individual number is limited to one time by Part 68 of the FCC rules. If the number of automatic redials is set to two or more, this may violate the FCC regulations.

VisualBright

The VisualBright function works automatically to provide a higher quality picture on your screen with programs such as Windows Media Player, Panasonic's DV Capture and Movie Messenger, and InterVideo WinDVD™2000.

This function is only effective at the actual resolution of the LCD screen, 1024x768 pixels.

NOTE

- VisualBright processes the central 80% of the window image to determine how the entire image will be enhanced.
- Turn this feature off when you are not using applications that benefit from enhanced picture playback. This will free memory and other system resources for use by those applications.

● When you want to turn this feature off

Select the  icon in the taskbar with the [right] mouse button, and select [Close].

VisualBright restarts after you [Shut Down] the computer or use the [Start] - [Shut Down] - [Restart] process.

VisualBright is not restarted when resuming from the hibernation mode or by running the program from the shortcut in the [Start Up] window.

NOTE

- The ability of VisualBright to process images in multiple windows may be affected by the contents and position of those windows.
- When you open a text display window that overlaps the display of a processed graphic window, the enhancements are removed in favor of the text display. If the processed graphic window is maximized and you open a text display window, the enhancements will only be removed if the text mode window overlaps the detection region in the central 80% of the image.
- When you open multiple processed graphic windows, the selected graphic window will benefit from the enhanced display.

Maximized high image quality display

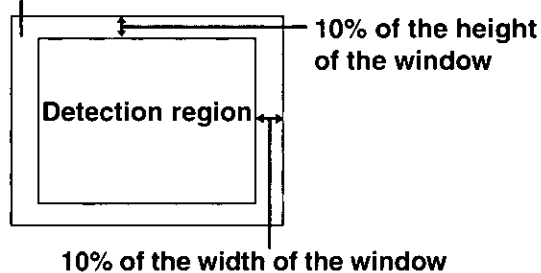

Using USB Devices (e.g., Floppy Disk Drive, Printer)

USB Root Hub

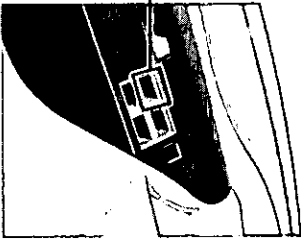

It is possible to use a variety of USB compatible peripheral devices such as an external floppy disk drive (included with the computer), printer, and image scanner. (Refer to the instructions manual provided with each USB compatible peripheral device.)

The computer has four USB ports. Among them, one is the root hub (see the figure on the left), and the other ports are USB hubs. Depending on the peripheral device, there are cases in which a device not connected to the root hub will be unable to operate.

When Installing a New Device Driver

After installing a device driver, be sure to perform the following procedure. (This procedure is unnecessary for the keyboard, mouse and external FDD included with this computer.)

If this procedure is not performed, the [Update wizard for new hardware] may be displayed when the computer resumes from the hibernation mode and problems may emerge in the operation thereafter.

- ① Click [Start] - [Run].
- ② Input the following:
c:\util\usbroot.bat
- ③ Click [OK], and then follow the on-screen instructions.
- ④ When [Finished] is displayed, click in the top right corner.
- ⑤ Select [Restart] in [Start] - [Shut Down] and select [OK].

The computer will restart.

- When the above procedure is performed, after the computer restarts, once again install the driver of the USB device because the [Update wizard for new hardware] will run again.

NOTE

● USB root hub and USB hubs

The USB root hub is a port directly connected to the computer. The USB hubs are connected to the computer internally through the USB root hub. (Image of the internal structure.)

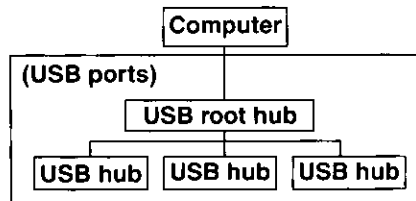

● Adding USB Hub

A USB hub can be connected to any one of the four USB ports. Follow the instructions manual accompanying the USB hub.

Operation

Using the Floppy Disk Drive

To use floppy disks, connect the included external floppy disk drive.

CAUTION

- A bus power type USB hub cannot be used.
- Do not compress or uncompress by drive space 3 in a floppy disk drive.
- Only one external floppy disk drive can be connected to the USB hub or USB ports of the computer.
- Another floppy disk drive cannot be used at the same time.

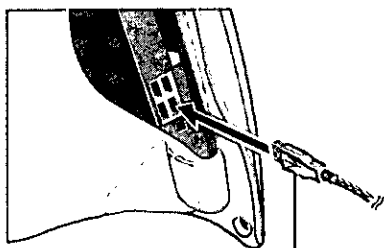

Be sure the  mark is facing towards the back of the computer.

1 Connecting a floppy disk drive.

The floppy disk drive can be connected to any one of the four USB ports.

NOTE

- It is not necessary to install the driver from the floppy disk provided with the external floppy disk drive.
- It is not possible to start up the computer from a floppy disk drive.

Inserting / Removing the Floppy Disk

<Inserting a disk>

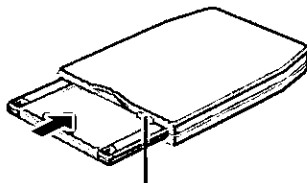

Eject Button

Insert the disk properly until the floppy disk ejection button pops out.

<Removing a disk>

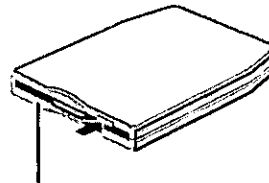

Access lamp

After confirming that the drive access lamp is not lit, press the eject button.

CAUTION

- Do not remove a floppy disk while the drive access lamp is lit. The data on the floppy disk may become corrupt.
- When carrying the floppy disk drive or storing it away, be sure to remove the floppy disk from the drive first.

NOTE

Types of floppy disks able to be used and disk capacities

There are two types of floppy disks: [2HD] and [2DD]. The capacity of each is as follows. ([2HD] has an approximately 2x capacity over [2DD]).

2HD: 1.44 Mbytes

2DD: 720 Kbytes

Using USB Devices (e.g., Floppy Disk Drive, Printer)

Using the Printer

It is possible to use a USB-compatible printer.

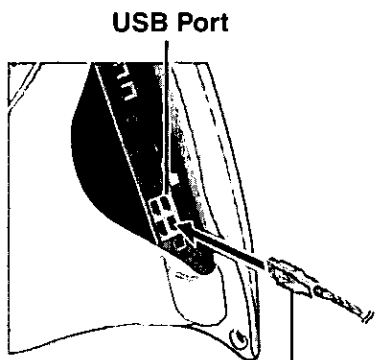

Be sure the  mark is facing towards the back of the computer.

1 Connect the printer to your computer.

NOTE

Use the cable that is included with the printer.

2 Turn on the printer, then turn on the computer.

3 Setting your printer.

Go to [My Computer] - [Printers]. Find your printer's icon, double-click on it, and click [File] - [Set As Default]. If no icon is available, select [Add Printer] and then follow the on-screen instructions.

NOTE

You may need to install a driver for your printer. Follow the on-screen instructions and refer to the operation manual of the printer on how to install the driver.

Using PC Cards

Your computer has one PC Card slot. The slot conforms to the PC Card Standard; therefore, communications or SCSI devices may be utilized.

PC Cards are classified into three categories depending on the card thickness: Type I (3.3 mm), Type II (5.0 mm), and Type III (10.5 mm).

For this computer, only a Type I or Type II card can be used.

CAUTION

- Check the PC Cards' specifications. Be sure the operating current does not exceed the specified limit. Damage may result otherwise.
Allowable Current: 3.3 V: 500 mA, 5 V: 400 mA
- Refer to the instructions manual provided with a PC Card for information on how to use the PC Card.
- Do not install / remove a PC Card while your computer is in the hibernation mode.

When inserting a card

This is the labeled side.

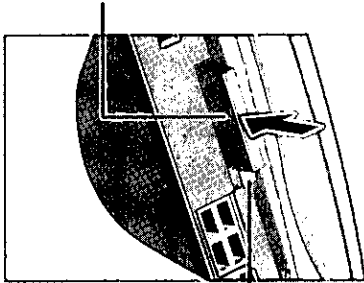

The eject button will pop out.

- 1 Press the ejection button and remove the dummy card** (☞ below)
The dummy card is inserted at the factory to protect the PC Card slot.
- 2 Set the labeled side of the PC Card to the rear of the display and slide the card firmly into the slot**
After inserting the card, the display will freeze temporarily. After confirmation of the card, the computer will return to its original condition.

CAUTION

When inserting a card, do not force the card in if difficulty is encountered. You may damage the slot, making it impossible to remove the card.

Removing the PC Card

Follow the steps below to remove a PC Card.

(Perform only step 4 when a dummy card is inserted in the slot.)

CAUTION

When removing a CardBus or network card, be sure to remove the card after turning the computer off.

- 1 Select [Start] - [Settings] - [Control Panel] - [PC Card (PCMCIA)]**
- 2 Select the PC Card slot and select [Stop], then select [OK]**
- 3 When the message [You may safely remove this device.] is displayed, click [OK]**
(The message may be hidden behind another display.)
- 4 Press the button and slide the PC Card out**
When the button is pressed, there is a beep sound and the PC Card comes out slightly. At this time, remove the card.

Eject Button

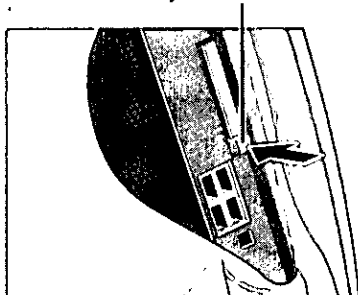

NOTE

- When removing a PC Card after turning off the computer, step 1-3 are not needed.
- When a PC card is not being used, we recommend inserting the dummy card into the slot to prevent dust and other objects from entering the slot.
- If the computer enters hibernation mode and resumes under the condition that an external drive (such as a hard disk drive or PD drive that uses a PC Card) is connected, the number of windows of the connected drive may increase.

Using Audio Devices

Microphone / Headphone / Speaker



Headphone Jack

Use this jack to connect headphones or amplifier-equipped speakers. Audio output from the internal speaker is disabled when headphones or external speakers are connected.

Microphone Jack

Use only a monaural condenser microphone (miniature jack).

CAUTION

- Using an input source other than a normal dynamic microphone may not allow audio to be input or may damage the equipment.
- When an external microphone is connected to the microphone jack, the internal microphone cannot be used.

NOTE

About adjust the sound volume (☞ page 8, 22).

Optical Digital Audio Output Terminal

It is possible to connect a Home Theater System or other Panasonic digital audio device with an optical input connector to this terminal. (The optical digital cable* is necessary.)

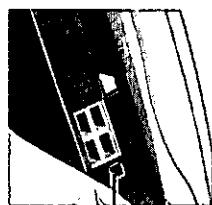

*The cable type may differ depending on the shape of the optical input connector of the device to connect.
Be sure to read the instructions manual of the device.

Optical Digital Audio Output Terminal

To connect a device, perform the following steps:

- ① Cut the power of the computer and the device to connect.
 - ② Remove the cap on the computer (☞ page 9).
 - ③ Connect the optical input terminal of the device with the optical digital audio output terminal of the device to connect with the above cable.
- Read the instructions manual of the device for information on how to record sound media.
 - When the optical digital audio output terminal is not being used, be sure to attach the cap to protect the terminal.

NOTE

When no sounds are being output, double click the [YAMAHA DS-XG Audio Config] icon of the [Control Panel] and confirm the settings of the [Digital Output] tab (☞ page 23).

Adding Memory

CAUTION

- Use a RAM module meeting the RAM module specifications below. If a module is used that does not meet the specifications, there are cases in which data may become unusable or the computer may not operate properly.
- RAM modules are extremely sensitive to static electricity. There are cases where static electricity generated by the human body has adversely affected such modules. In addition, it is easy to damage the RAM modules or internal components of the computer. Therefore, when installing or removing a RAM module, handle the module with extreme care.

The memory capacity can be confirmed in the [Main] menu of the Setup Utility (☞ page 50). The memory capacity at the time of purchase is 64 Mbytes. This capacity can be expanded by installing another separate RAM module. Follow the procedure below to add or remove a RAM module.

RAM module specifications

144 pins, SO-DIMM, 3.3 V, SDRAM

- 1 After completing operations and power off the computer** (☞ page 17), **remove the AC cord**

Also remove all cables connecting peripheral devices, e.g., USB devices.

CAUTION

- In the hibernation mode, do not insert or remove a RAM module. The computer may be damaged or may fail to work properly.
- Be sure to spread a soft cloth so that marks do not appear on the display.

- 2 Set the computer so that the display is facing downwards**

- 3 Using a small-sized Philips screwdriver, remove the four screws**

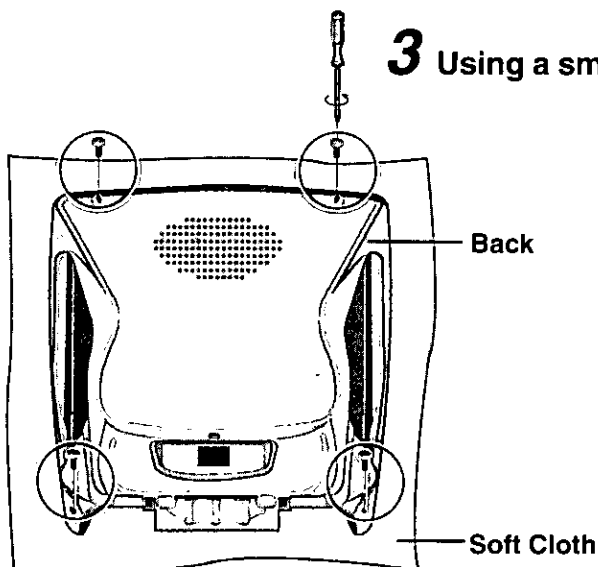

Adding Memory

4 Remove the four screws of the stand and then remove the cabinet

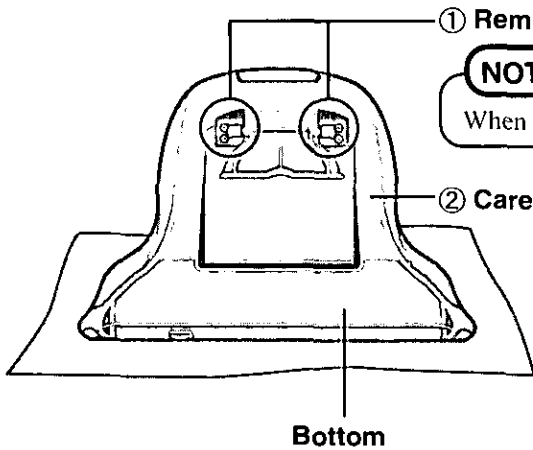

NOTE

When removing the cabinet, it is not necessary to remove the stand.

5 Remove the RAM Module Cover

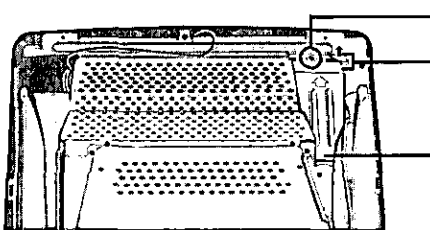

CAUTION

We recommend using gloves to prevent the metal from cutting your hands.

(To next page)

6 Inserting / Removing the RAM module <When inserting a module>

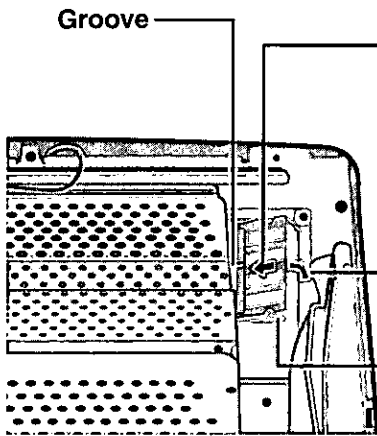

- ① Insert the RAM module at an angle.

NOTE

Be aware of the direction and angle of the RAM module when inserting it. It will be difficult to insert the module if there is a mistake in the direction and angle between the RAM module and the slot.

- ② Push down on the RAM module until it locks with the top and bottom hooks.

Hooks (on both sides)

<When removing a module>

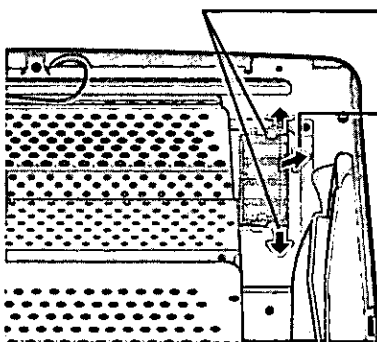

- ① Move the hooks on both sides to the outside direction.
The RAM module will rise at an angle (dotted line).

- ② Remove the RAM module at an angle.

7 Replace the cover and screws removed in Steps 3 to 5

DV Capture

It is possible to use the DV Capture functions below by connecting a digital video camcorder (sold separately) to the computer.

- Functions to play recorded images on the computer
- Functions to save a part of the input from recorded images or a digital video camcorder as a moving image or still image file
- To display or play the contents saved to a file

Connecting a Digital Video Camcorder

Prepare the following items.

- Digital video camcorder (sold separately)
- DV Interface Cable (4-to-4 pin) (sold separately)
- MiniDV tape on which images are recorded (sold separately)

NOTE

DV Interface Cable

This is a cable (4-to-4 pin) that connects the DV input/output connector (IEEE 1394 standards) of a digital video camcorder to the IEEE 1394 interface connector of the computer. The name the camera is known by differs depending on the product (e.g., i.LINK cable). For questions, contact Panasonic at 1-800-272-7033.

1 Turn on the computer and the digital video camcorder (☞ page 13)

Refer to the instructions manual included with digital video camcorder.

CAUTION

- Be sure to connect a DV interface cable after the power is ON.
- When DV capture is being employed, take caution so that the power of the digital video camcorder connected to the computer is not cut off. When a digital video camcorder in the camera mode is being used, the power may be cut off automatically when a tape is inserted.

2 When capturing recorded contents

Insert a MiniDV tape (recorded by a digital video camcorder) and select the VCR mode.

● When capturing input from a digital video camcorder

Select the camera mode on a digital video camcorder.

3 After confirming Windows has started up, connect a digital video camcorder to the computer with a DV interface cable

Refer to the instructions manual included with digital video camcorder.

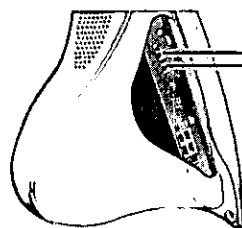

IEEE 1394 Interface Connector

DV Input/Output Connector

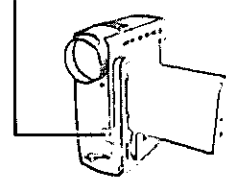

Example of a digital video camcorder

CAUTION

- With "DV Capture", do not simultaneously use the two IEEE 1394 Interface Connectors.
- When connecting a camcorder for the first time, a dialog box may appear to install the device driver.
- When a digital video camcorder is connected, the sound volume adjustment icon may be displayed in the taskbar. You can choose to stop the display in the taskbar by double-clicking the [Multimedia] icon in [Control Panel] and removing the check mark for "Show volume control on the taskbar" in the [Audio] tab.

When Removing the Digital Video Camcorder

- ① Turn off the computer and remove the cable from the IEEE 1394 Interface connector of the computer.
- ② Turn off the digital video camcorder and remove the cable .

Before Running DV Capture

- Close all moving image application software like games using a capture driver, overlay function, or Direct Draw and Direct Sound.
- Set either of the following display options and number of colors for the display properties.
800 by 600 pixels :High Color (16-bit), True Color (24-bit), or True Color (32-bit)
1024 by 768 pixels:High Color (16-bit) or True Color (24-bit)

Running DV Capture

1 Confirm that the digital video camcorder is properly connected

(☞ page 36)

- ① Click [My Computer] with the right button, and then select [Properties] - [Device Manager].
- ② Confirm that [Microsoft DV Camera and VCR] is displayed at the [Imaging Device].

NOTE

Make the necessary settings for "Before Running DV Capture".

2 Select [DV Capture] icon on the desktop

CAUTION

When DV Capture is running, do not perform the following operations. The operation of the computer may become unstable.

- Change the display size or number of colors in [Display properties].
- Power the digital video camcorder ON/OFF.
- Switch between the VCR/camera mode of the digital video camcorder.
- Remove a DV interface cable.
- Perform play/stop/fast-forward/rewind using the buttons of the digital video camcorder.

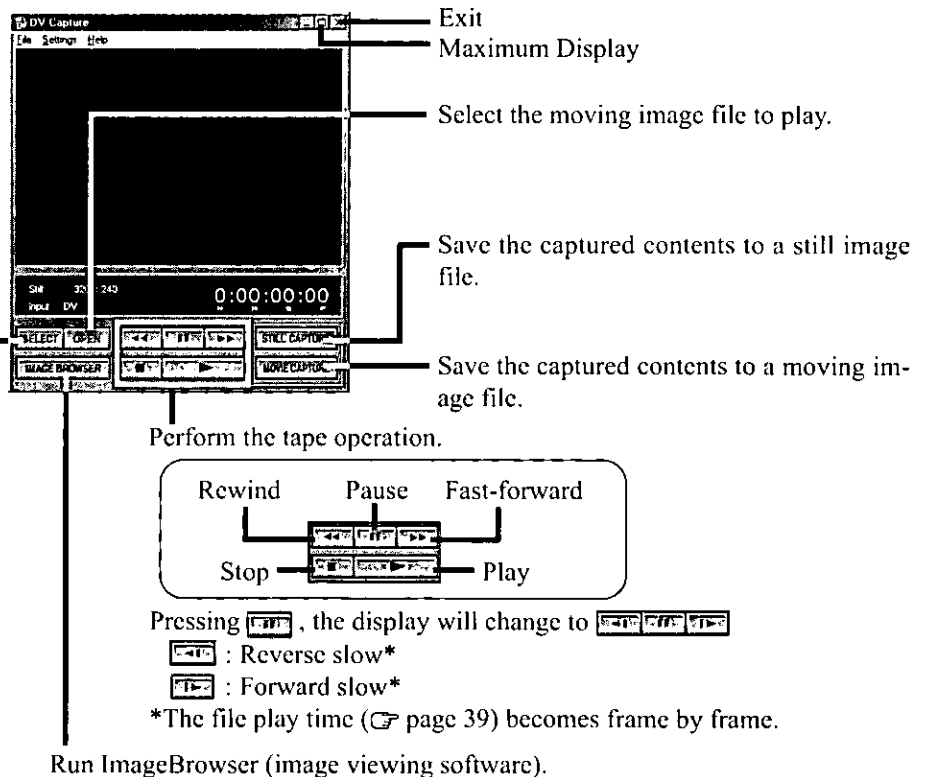

You can switch between digital video camcorder playback and moving image file captured.

NOTE

Before Capturing Moving Image

- **Before performing moving image capture (to prevent frame dropping and to perform the capturing correctly)**
 - Close all other applications and resident applications such as virus checkers.
 - Do not use any communication function.
 - Click the desktop (wallpaper) with the right button, and remove the check mark next to [View As Web Page] in [Active Desktop].
 - Click [Start] - [Programs] - [Accessories] - [System Tools] - [Disk Defragmenter], and execute "Optimize" for the C drive.
- **About the possible display sizes**
 - 360 by 240 pixels display size
 - Maximized display size
 - It is possible to maximize an image display by pressing the "maximize" button (the image quality will be degraded).
 - When DV Capture is running, it is not possible to enter the hibernation mode.

Movie Capture

It is possible to save scenes as a moving image file from images recorded on tape or inputs from a digital video camcorder.

1 Running DV Capture (☞ page 37)

2 Playing the tape and then perform moving images capture as follows

① Confirm that "DV" is displayed

When "DV" is not displayed, click [SELECT].

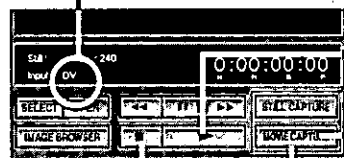

② Click  To display incoming DV data

③ Click [MOVIE CAPTURE] to begin capture

- During moving image capture, do not perform other operations like moving the mouse.
- During capture, the capture time is displayed.

④ Click again to end the capture
The capturing ends, but the playback continues.
or, click 

- The maximum capture time is about three minutes. One minute is equal to a file size of about 230 Mbytes.
- Captured images cannot be saved on a compressed drive. In addition, voice over and wide sound capture are not possible.
- It may not be possible to perform capture properly when capturing the starting or ending part of a tape or there are parts on a tape that include unrecorded parts.
- When the contents of a tape are mixed between the (SP/LP) camera mode, it may not be possible to correctly capture the boundaries sharing these two modes. Perform capture in the range of the same camera mode.
- If the remaining capacity of the hard disk is below about 300 Mbytes, capturing stops automatically.
- Special functions of a digital video camcorder (e.g., effects and multi-displays) may not work properly.

(To next page)

● About capturing

Moving images that are captured are automatically saved to the folder (and with the file names) shown below.

The file type is an AVI file (*.AVI) of the DV format of 30 frames/second, with a size of 720X480 pixels.

The date of creation and time are automatically attached to a part of the file name. As an example, an image captured on August 25, 2000 at 1:08'14 p.m. is given the following name.

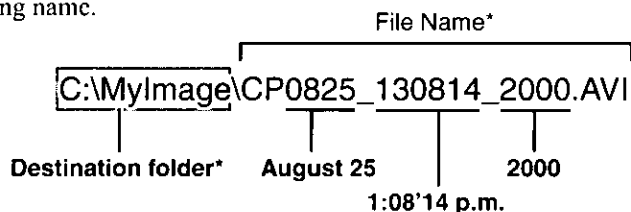

* The destination folder and file name can be changed (☞ page 42).

3 Select to stop the playback

Playing Captured Movie Files

1 Running DV Capture (☞ page 37)

2

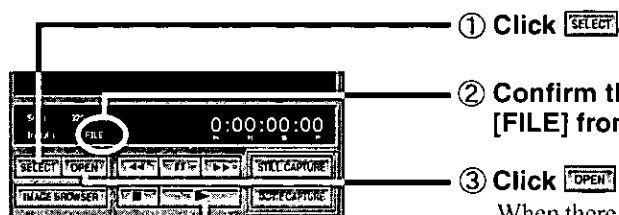

① Click **SELECT**

② Confirm that the display changes to **[FILE]** from **[DV]**

③ Click **OPEN**

When there are multiple moving image files, click **[OPEN]**, select the folder and moving image file (*.AVI), and then play the file. A file that is not an AVI file of the DV format cannot be played.

Playback should begin automatically.

④ Click **PLAY**

The playback of the file finally commences.

CAUTION

AVI files saved to an external drive (e.g., removable disk drive) may not be played correctly. Play such files after copying them to the hard disk drive (internal).

NOTE

Output to a digital video camcorder

- Images of AVI files of the DV format can be output to a digital video camcorder connected to the IEEE 1394 interface connector during the playback.
- It is possible to add special effects to an AVI file of the DV format with commercially available non-linear image editing software applications (e.g., Adobe Premiere) and perform rewrite recording over tapes. (The recording is done through operations on the camcorder side.)

DV Capture

- When selecting a file to be played from the ImageBrowser

1 Select [IMAGEBROWSER] from the [DV Capture] window
The starting image of each moving image file is displayed.

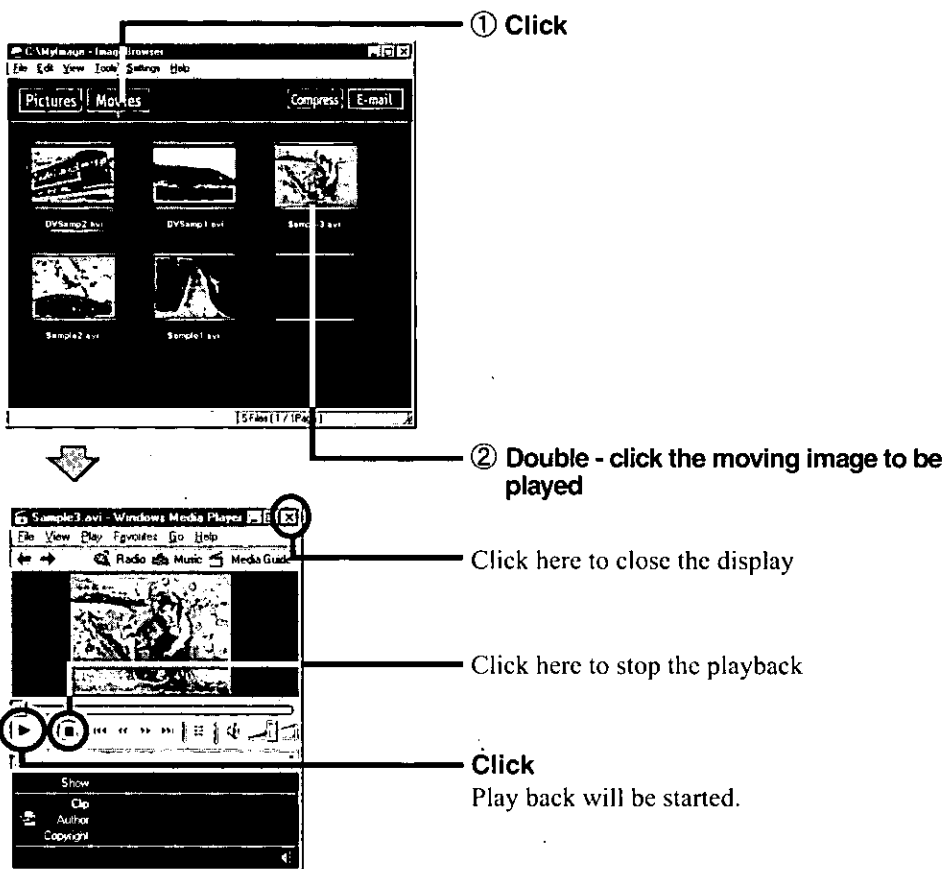

NOTE

The computer may restart even when [Shut down] in [Shut Down] is executed, when an AVI file or MPEG file is being played using the Windows Media Player.

Still Capture

It is possible to save a scene as a still image file from images recorded on tape or inputs from a digital video camcorder.

1 Running DV Capture (☞ page 37)

2 Play the tape and then perform still image capture

① Confirm that "DV" is displayed

When "DV" is not displayed, click [SELECT].

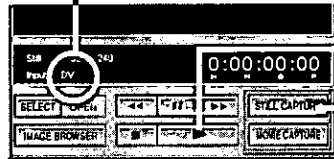

② Click 

③ Click [STILL CAPTURE] for the scene to capture

One file is saved for each click. In addition, it is possible to capture a still image in the [Pause] mode.

- The file formats for captured images are JPEG and BMP (*.JPG and *.BMP, respectively).
- JPEG images of a 320 by 240 pixels size and with about 16 million colors can be captured under the default conditions; the file size is about 30 Kbytes per image. (The format and size of an image, and the colors of the image, can be changed through [Still settings] (☞ next page). The file size will change depending on the settings.)
- The file name and destination of a captured still image are as follows. The date of creation and time are automatically attached to a part of the file name. As an example, an image captured on August 25, 2000 at 1:08'14 p.m. is given the following name.

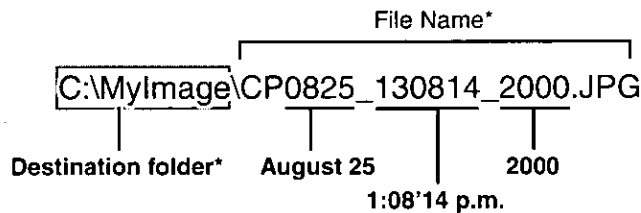

* The destination folder and file name can be changed (☞ page 42).

- When multiple captures are being performed at the same time, numbers are added to the ends of the file names as follows.
CP0825_130814_2000_01.JPG
CP0825_130814_2000_02.JPG
CP0825_130814_2000_03.JPG
(The added numbers go from 01 to 99. Saving is not possible over 99.)
- Special functions of a digital video camcorder (e.g., effects and multi-displays) may not work properly.

Viewing Still Image Files

It is possible to display a list of files and maximize displays with ImageBrowser (image viewing software).

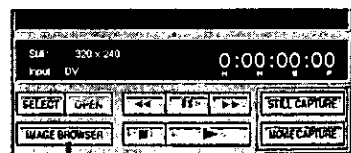

Click 

Detailed Settings for Still Image Capturing

- 1 Running DV Capture (☞ page 37)
- 2 Select [Settings] and then [Still Settings]
- 3 Make the still image settings and click [OK]

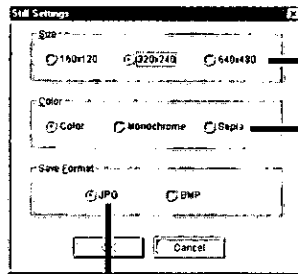

Select the size.

Select the color option of the image.

- Color : About 16 million colors (24-bit)
- Monochrome : 256-step gray scale
- Sepia : 256-step sepia colors

Select the format to save the image in (i.e., either JPEG or BMP).

NOTE

- File sizes differ according to the size of the image and color settings.
- It is also possible to change the settings by using the pop-up menu displayed when clicking the right button over the display of Step 2.

Changing the destination folder and file name

It is possible to change the destination folder and file name by running [DV Capture] and selecting [Folder Settings] from the [File] menu.

It is possible to change the destination folder.

(However, it is not possible to make settings for drives other than the C drive.)
The factory set destination folder is C:\MyImage.

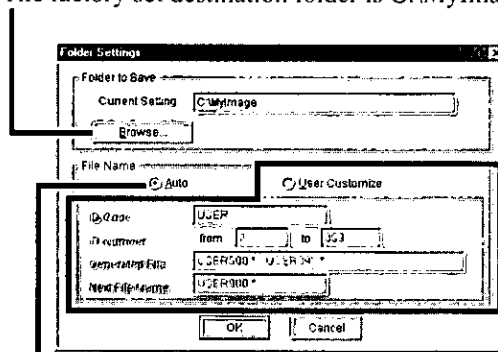

User Customize

It is possible to freely designate the name (ID Code) attached to the head of a file name with eight characters. However, the following characters cannot be used.

\\/: * ? " < > |

(The default name is set to USER.)

In addition, it is possible to set the range of the three numerals added at the end of the name (ID Number 000 to 999). (However, identical files will be overwritten.)

Auto create

This is the factory set.
[CP] is added at the top of the file name, followed by the automatic addition of the date of creation and time (☞ page 39, 41).

Example: USER000.JPG

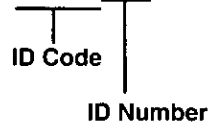

Using Image Files

The functions below are available on ImageBrowser (image viewing software).

- Functions to view a list of image files like an album.
- Functions to send images from the list as mail. (☞ page 46)
- Functions to compress moving images and send them attached with a player as mail (Movie Messenger; ☞ page 47).

NOTE

For details, refer to the help file for each function.

Running ImageBrowser

1 Select [IMAGEBROWSER] icon on the desktop

With the default settings the contents of the [C:\MyImage] are displayed. To change the folder of images shown in ImageBrowser, click [File] - [Open Folder] in order.

Display of a single image

Shows images of BMP files and JPEG files in the display image folder.

Activation of Movie Messenger (☞ page 47)

It is possible to compress a selected moving image file into a player-equipped executable file. It is also possible to send the compressed moving image file as an attachment.

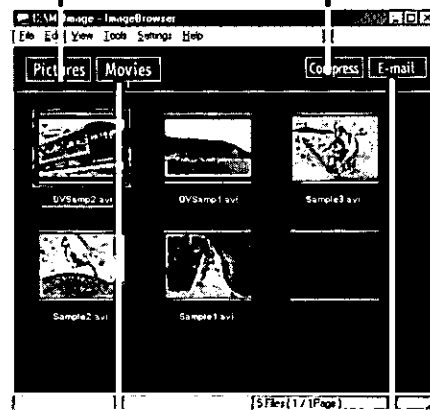

Display of moving images

Displays still images of files in the AVI format and still images of Movie Messenger in the display image folder.

Sending mail

It is possible to activate a mail software application and to send a selected image file as an attachment.

NOTE

About the TMPWORK folder

This is automatically created under the designated display image folder. This folder is created to store temporary files (*.BMS) that display the first frames of the individual moving image files (*.AVI). The TMPWORK folder to be created under the display image folder can be set for each drive in [Settings Temporary Folder] under the [File] menu.

Using Image Files

Displaying Images

If an image is double-clicked, an application will open to display a single image or to play a moving image file.

For a single image (*.BMP)

Microsoft Paint will open and the selected image will be displayed.

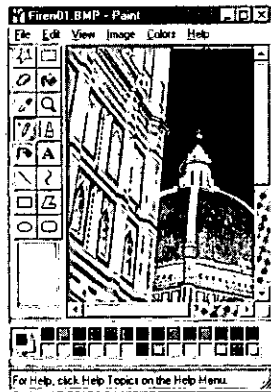

For a still image (*.JPG)

Imaging will open and the selected image will be displayed.

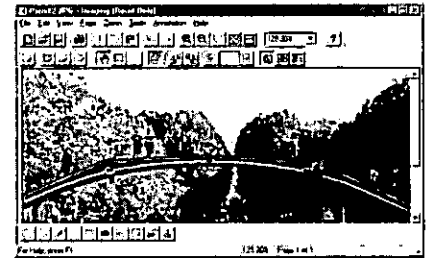

For a moving image (*.AVI)

Windows Media Player will open. The image will begin playing when the play (▶) button is clicked.



NOTE

The computer may restart even when [Shut down] in [Shut Down] is executed, when an AVI file or MPEG file is being played using the Windows Media Player.

About the menu commands of ImageBrowser

The main commands are as follows.

[File] menu

- Settings Temporary Folder :Changes the folder to display images.
- Register a Related Application :Registers applications to display images.
- Select and Execute a Related Application :Selectively opens applications to display images.

[Edit] menu

- Copy :Copies a selected image to another folder.
- Delete :Deletes a selected image file.

[View] menu

- Auto Update :Automatically updates a display to new conditions.
- Size :Changes the display size of listed images.
- Slide :Automatically scrolls the display of an image.

[Settings] menu

- E-mail Settings : "Mail software settings" (page 45)

Sending Image Files By Mail

It is possible to open a new mail creation screen with an attached image with one click, through the use of one of the mail sending functions of the ImageBrowser. This is very convenient as it is no longer necessary to look for the file name of the image to send.

The following types of mail sending functions are available from ImageBrowser.

- Select a single image or moving image file from the displayed list, and send the file as an attachment. (☞ next page)
- Compress a moving image file, attach it to an executable player, and send the executable as an attachment. (“Movie Messenger” ☞ page 47)

NOTE

It is necessary to use a MAPI mail software application.

Depending on the mail software application that is used, an application may have to be started up beforehand.

Mail software settings

The following settings need to be made beforehand to use the individual mail sending functions of the ImageBrowser.

1 Running ImageBrowser (☞ page 43)

2 Click [E-mail Settings] under the [Settings] menu and make the settings

When a non-MAPI software application is used, select [Others].

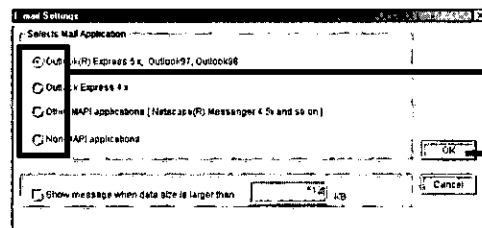

① Select a mail application to use

② Click [OK]

● When using a non-MAPI software application

The automatic execution of the mail software application is not possible even if [E-mail] is clicked in the ImageBrowser or Movie Messenger. Open the mail software application beforehand.

If the message on the right is displayed, click [Yes], select the image file to send, and attach it in the mail software.

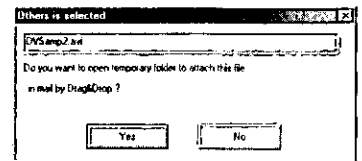

● When using Outlook Express or Outlook 97/98

When a binary file is attached in Outlook Express or Outlook 97/98, the file may be unable to be read correctly depending on the software used on the receiving side. In such cases, in the settings for sending mail in Outlook Express or Outlook 97/98, select text style for the sending style. In addition, set MIME (encoding method) for the binary form for attachments. For details on the settings, read the help file or manual of Outlook Express, Outlook 97/98 or of the application you are using.

Using Image Files

Sending Mail From a List

1 Running ImageBrowser (☞ page 43)

① Click the still image to send by mail

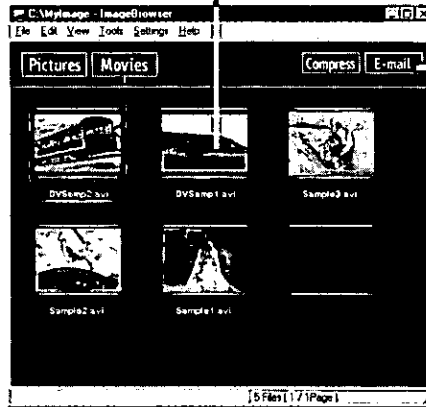

② Click
The mail software is activated.

NOTE

- When the [E-mail Settings] display appears, make the “Mail software settings” (☞ page 45).
- **Sending a moving image file by mail**
The contents of a moving image file is large, and so we do not recommend sending the file uncompressed.
Compress a moving image file first with Movie Messenger (☞ page 47) before sending it.

2 Write a message and then send the mail

Follow the on-screen instructions.

Compressing and Mailing Moving Images (Movie Messenger)

It is possible to compress moving image file, attach it to a player (Windows 95/98 only) and send it by mail.

NOTE

- The mail software application that can activate from Movie Messenger is only Outlook Express 5.X.
- Movie Messenger is compatible with AVI files (*.AVI) of the moving image DV format included in DV Capture.
- Movie Messenger can also be opened by clicking [Movie Messenger] icon on the desktop.

1 Open Movie Messenger from the ImageBrowser (☞ page 43)

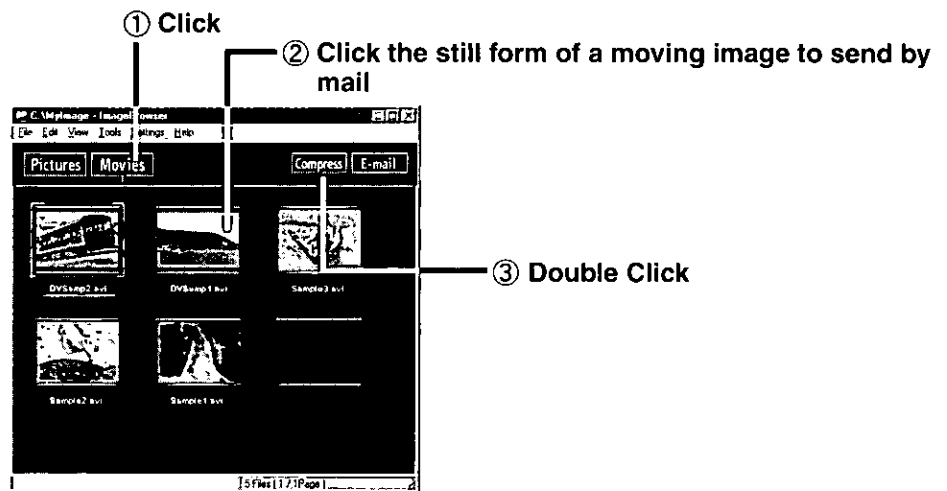

2 Make the compression settings and compress the file

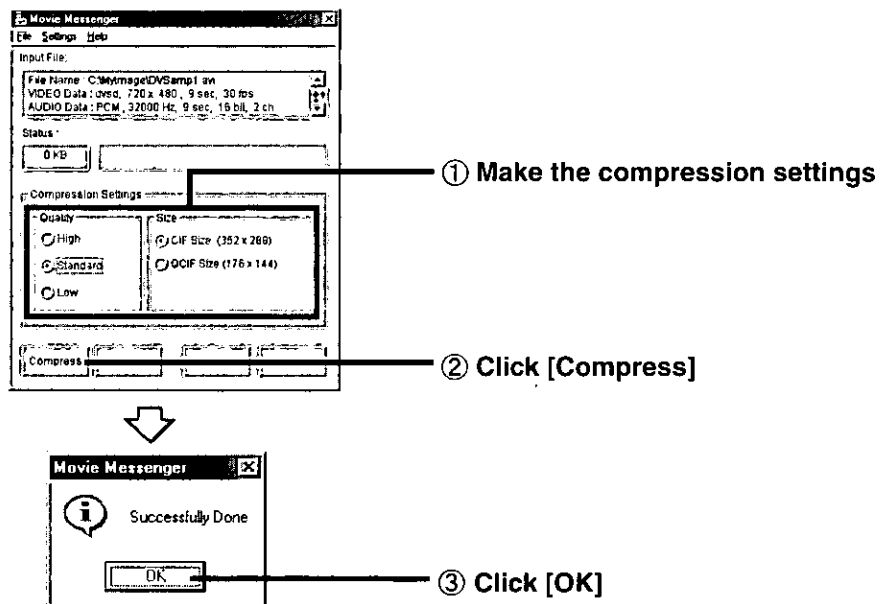

NOTE

About the image file after compression

The size of the original image file will become smaller. In addition, the movements may no longer move smoothly compared with the original moving image file, because of the reduction in the number of frames per second.

Using Image Files

3 Run the mail software

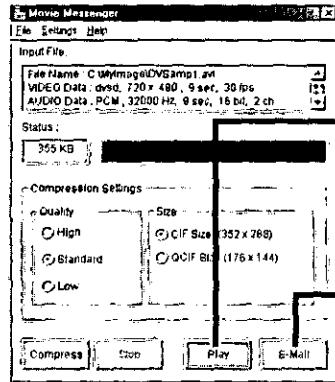

① Click [Play]

A proprietary player application will open.
Confirm the compressed file.

② Click [E-mail]

NOTE

When the [E-mail startup settings] display appears, perform the "Mail software settings" (☞ page 45).

4 Write a message and then send the mail

NOTE

This player will only run if the receiving side is running Windows 95/98. It will not operate in any other OS environments.

Setup Utility

An explanation is given below on a utility program (i.e., Setup Utility) for displaying the BIOS information and for setting the password.

Running the Setup Utility

- 1 Turn on your computer by pressing the Power Switch or restart using the [Start]-[Shut Down]
- 2 When [Press <F2> to enter SETUP] message is displayed, press **F2**

NOTE

- This Setup Utility will not be run if **F2** is not pressed soon after the computer is started. In this case, you need to restart your computer again.
- If “Enter your password” is displayed, input your password. (☞ page 50)

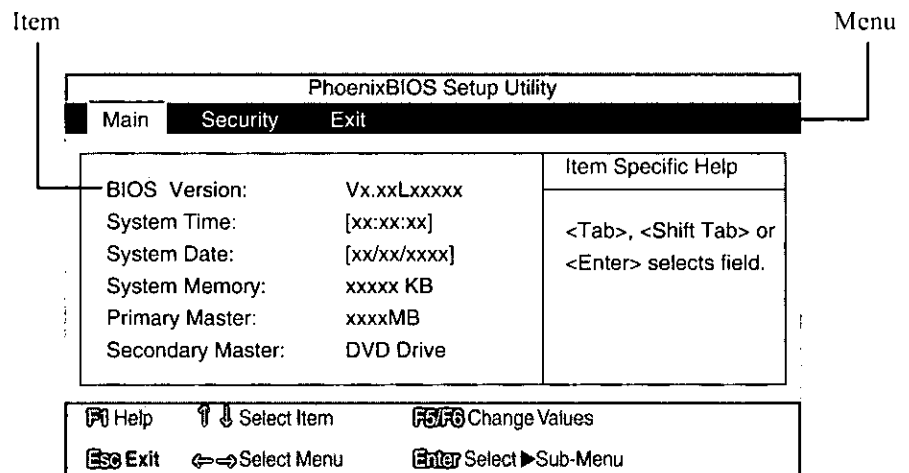

● Closing the Setup Utility

- 1 Using **←** and **→**, select [Exit] menu and then press **Enter**

Windows will start.

When the password has been set, it will be necessary to input the password before Windows can start up.

NOTE

- Key Operations**
- F1** :To display the “General help” file.
 - Enter** :To display sub-menu.
 - Esc** :To display [Exit] menu.
 - ←** **→** :To move among the menus.
 - ↑** **↓** :To move among the items.
 - F5** **F6** :To move among the values.

Setup Utility





Main Menu

1 Select [Main] menu with keys

It is possible to confirm the current capacity of the memory and the BIOS version.

It is possible to confirm the date and time set on the computer. It is also possible to change the settings.

Changing the system time/date

- 1 Press   and move the cursor to the item.
- 2 Press  and match the cursor to each item for [HH:MM:SS] and [MM:DD:YY], and then press  (to go back) or  (to proceed).

BIOS Version:	Vx.xxLxxx
System Time:	[xx:xx:xx]
System Date:	[xx/xx/xxxx]
System Memory:	xxxxx KB
Primary Master:	xxxxMB
Secondary Master:	DVD Drive

The left example shows the default settings (factory condition).

Security Menu

This protects the start up of the computer and the start up of the setup utility with a password.

1 Using and , select [Security] menu

2 Set the User Password

- 1 Enter your password at the [Enter New Password], then press [Enter].
- 2 Re-enter your password at the [Confirm New Password], then press [Enter].

3 At the [Setup Notice], press

CAUTION

- Your password will not be displayed on the screen.
- Do not forget your password. If a password is forgotten, you will be unable to use your computer. Contact Panasonic at 1-800-272-7033.

NOTE

Start up when the password is set

The computer asks for the password as shown below for the start up of the computer or the start up of the setup utility. Input the password.

The password should be written down somewhere just in case it is forgotten. There is no method to release a forgotten password.

Enter your password []

After three incorrect input attempts,

The computer powers off.

The computer returns to the hibernation mode, if it had resumed from the hibernation mode.

List of Error Codes

After a hardware (or some other) error has occurred, the "POST Startup Error(s)" screen appears during system startup and an error code (see below) is displayed.

If a message with an asterisk (*) mark is displayed, run the Setup Utility and try restarting the computer. Then, run the Setup Utility again and make your desired settings.

If a message without an asterisk (*) mark is displayed, write down the message and contact Panasonic at 1-800-272-7033.

0200 Failure Fixed Disk

Fixed disk is not working or not configured properly. Run the Setup Utility and check that the hard disk capacity is displayed at [Primary Master]. If the [None] is displayed, disk error is occurred.

0210 Stuck key

Stuck key on keyboard. Confirm the keyboard is connected to the computer and that a key is not being held down.

0211 Keyboard error

Keyboard not working. Confirm the keyboard is connected to the computer and that a key is not being held down.

0212 Keyboard Controller Failed

Keyboard controller failed test. May require replacing keyboard controller.

0213 Keyboard locked - Unlock key switch

Unlock the system to proceed. Confirm the keyboard is connected to the computer and that a key is not being held down.

0230 System RAM Failure at offset : *nnnn*

System RAM failure at offset *nnnn* of in the 64k block at which the error was detected. If you installed RAM module, remove the RAM module and reinstall it.

0231 Shadow RAM Failure at offset : *nnnn*

Shadow RAM failure at offset *nnnn* of the 64k block at which the error was detected. If you installed RAM module, remove the RAM module and reinstall it.

0232 Extended RAM Failed at offset : *nnnn*

Extended memory not working or not configured properly at offset *nnnn*.

***0251 System CMOS checksum bad - Default configuration used**

System CMOS has been corrupted or modified incorrectly, perhaps by an application program that changes data stored in CMOS.

The BIOS installed Default SETUP Values. If you do not want these values, enter Setup and enter your own values. If the error persists, check the system battery or contact Panasonic.

0260 System timer error

The timer test failed. Requires repair of system board.

0270 Real time clock error

Real-time clock fails BIOS test. May require board repair.

***0280 Previous boot incomplete - Default configuration used**

Previous POST did not complete successfully. POST loads default values and offers to run Setup. If the failure was caused by incorrect values and they are not corrected, the next boot will likely fail.

02D0 System cache error - Cache disabled

Contact Panasonic at 1-800-272-7033.

02F0: CPU ID:

CPU socket number for Multi-Processor error.

02F4: EISA CMOS not writable

ServerBIOS2 test error: Cannot write to EISA CMOS.

02F5: DMA Test Failed

ServerBIOS2 test error: Cannot write to extended DMA (Direct Memory Access) registers.

02F6: Software NMI Failed

ServerBIOS2 test error: Cannot generate software NMI (Non-Maskable Interrupt).

02F7: Fail - Safe Timer NMI Failed

ServerBIOS2 test error: Fail-Safe Timer takes too long.

device address Conflict

Address conflict for specified *device*. If you installed a PC Card, remove the PC Card and reinsert it. Following the procedures for "Stopping" a PC Card.

Invalid System Configuration Data

Problem with NVRAM (CMOS) data. NVRAM means 'Non-Volatile RAM'.

I/O device IRQ conflict

I/O device IRQ conflict error.

Operating System not found

Operating system cannot be located on drive C:. Enter Setup and see if fixed disk and drive A: are properly identified.

Parity Check 1 *nnnn*

Parity error found in the system bus. BIOS attempts to locate the address and display it on the screen. If it cannot locate the address, it displays ????.

Parity is a method for checking errors in binary data. A parity error indicates that some data has been corrupted.

Parity Check 2 *nnnn*

Parity error found in the I/O bus. BIOS attempts to locate the address and display it on the screen. If it cannot locate the address, it displays ????.

Dealing With Problems

When a problem occurs, refer to this page.

If you still cannot troubleshoot the problem, contact Panasonic at 1-800-272-7033.

● When the display freezes

When the display freezes while an application is running, close the application with the following procedure. However, the contents of all work that were not saved will be lost.

<When the keyboard and mouse work>

① Press **Ctrl** + **Alt** + **Del**

The [Close Program] window is displayed. It may take time before the window is displayed depending on the application. If there is no display after a period of 30 seconds, proceed to Step ④.

② Click the application for which [No response] is shown from the list of applications, and then click [End Task].

③ When the confirmation message for "Close" appears, click [Close].

The selected application will be forcefully closed. It may take about 20 to 30 seconds until the application is closed.

④ If the [Close Program] window is not displayed or the application cannot be closed after a period of more than 30 seconds, press **Ctrl** + **Alt** + **Del** again.

The computer will restart.

If the computer does not restart even after pressing **Ctrl** + **Alt** + **Del** two or three times, press the reset button (⏻ below), or turn the power off, and then turn it back on several seconds later. Please note that you will lose all unsaved data in the applications that were running at the time of the freeze.

<When the keyboard and/or mouse does not work>

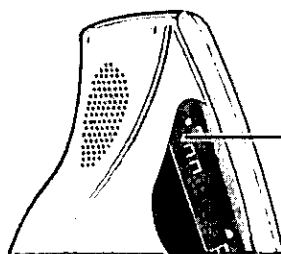

With a dull pointed object, press the reset button. (Do not use an implement that bends/breaks easily like a pencil.)

The computer will be forcefully shut down. After the computer shut down, turn it on again.

NOTE

To prevent the erroneous execution of an application

Confirm that there is enough free space on the hard disk.

When a lot of applications are open, close those applications that are unnecessary.

Be sure to click within the appropriate frame.

If the Microsoft ScanDisk program runs



After an application is forcefully closed or the computer is restarted, there are cases where the screen becomes blue and the scandisk program executes. The Microsoft ScanDisk program functions to check Windows and the state of the hard disk. If an error is found by the Microsoft ScanDisk program, follow the on-screen message.

Troubleshooting Suggestions

● Starting Up

<p>The computer cannot be started up</p>	<ul style="list-style-type: none"> ● Is the AC cord properly connected to the power terminal of the computer and/or a power outlet? ● Try restarting the computer after pressing the reset button in the computer OFF state. In this case, the Microsoft ScanDisk program may automatically run to detect errors on the hard disk. Follow the on-screen instructions. ● Try removing and then reinserting the AC cord of the computer and restart the computer. ● Confirm that access to the hard disk is possible. <p><Confirmation method></p> <ol style="list-style-type: none"> ① Set Product Recovery CD-ROM into the DVD-ROM drive. ② Restart the computer. ③ In the lower right of the display, when Press <F2> to enter Setup Press <ESC> to enter Boot First Menu is displayed, press (Esc). ④ Select [2. DVD Drive] and then press (Enter). ⑤ Select [4. Close]. ⑥ When "A:\>" is displayed, input "c:" and press (Enter). <ul style="list-style-type: none"> · When "C:\\" is displayed, there is a possibility that a file necessary to start Windows up is corrupt. It is possible to return the hard disk to factory condition by performing reinstallation with the procedure proposed in this manual. However, please understand that all data, applications or programs will no longer be used and may need to reinstall. · When "C:\\" is not displayed, consult with the retailer that you purchased the computer from or Panasonic at 1-800-272-7033.
<p>The date and time are incorrect</p>	<p>You can set the date and time through [Date/Time] in [Start] - [Settings] - [Control Panel]. If you continue to experience problems, the internal battery maintaining the clock may need to be replaced. Contact Panasonic at 1-800-272-7033.</p>
<p>You forgot the password</p>	<p>Contact Panasonic at 1-800-272-7033.</p>
<p>[POST Startup Error(s)] is displayed</p>	<p>☞ page 51</p>

● Operations

<p>Computer hangs</p>	<ul style="list-style-type: none"> ● Select [Restart] in [Start] - [Shut Down]. ● Refer to [When the display freezes] on page 52 and restart the computer. ● After powering down by pressing the power switch for more than four seconds, press the power switch to power on and open the application again. If the program no longer works normally, go to [Start] - [Settings] - [Control Panel] - [Add/Remove Programs] to delete the program. Then, try installing the program once again.
<p>The display becomes completely dark</p>	<p>The power of the display may automatically switch OFF with the Power Management function. Refer to page 21 on measures to take.</p>
<p>The computer is not outputting any sound</p>	<ul style="list-style-type: none"> ● Is the sound volume set to the minimum level or has [Mute All] been set for [Volume Control] in  on the taskbar ● Confirm that the sound setting in the application software is correct.
<p>No sound is output from the optical digital audio output terminal</p>	<p>Confirm that  is not on the left side of [OFF] or [ON (Direct)] at [Digital Output] of [YAMAHA DS-XG Audio Config]. (☞page 23)</p>
<p>MIDI sounds cannot be output</p>	<p>When a USB-compatible speaker is used, MIDI sounds will fail to be output when the USB speaker is removed and then reinstalled (while the computer is ON) or when the computer resumes from the standby state. In such cases, MIDI sounds can be output by restarting the computer.</p>
<p>A file can no longer be played using the Windows Media Player</p>	<p>If the sleep button is pressed or the computer is made to forcefully enter the standby state via the system standby setting in [Power Management] while a file is being played using the Windows Media Player, the file may no longer be played properly when the computer resumes.</p>

Troubleshooting Suggestions

● Operations

<p>The taskbar disappears</p>	<ul style="list-style-type: none"> ● Confirm that [Auto hide] setting is off, the taskbar was not resized or the taskbar was not moved to the side of the display. ● The taskbar can be made to appear by switching to the taskbar by pressing (Alt) + (Tab). ● Even though the taskbar is set to [Always on top], a window may be displayed in front of it.
--------------------------------------	--

● Hibernation Function

<p>Impossible to enter the hibernation mode</p>	<ul style="list-style-type: none"> ● Close all applications and try the hibernation function again. If you continue to experience problems, restart the computer and try hibernation function again. ● Reinstall [Advanced Power Management] with the following procedure. <ol style="list-style-type: none"> ① Click [Start] - [Settings] - [Control Panel], and then double click [System]. ② Click [Device Manager], select [Advanced Power Management Support] in [System Devices], and then click [Remove]. ③ When the confirmation message appears, click [OK], and then click [Yes] to restart the computer. ④ Double click [Add New Hardware] in [Control Panel]. ⑤ Click [Next] in the [Add New Hardware Wizard] screen and then click [Next] again. ⑥ Select [No, the device isn't in the list] and then click [Next]. ⑦ Select [Yes (Recommended)] and then click [Next]. ⑧ Click [Next]. ⑨ Click [Details], confirm the display of the [Advanced Power Management Support] message, and then click [Finish]. ⑩ Restart the computer.
--	---

● Display

<p>The screen has disappeared</p>	<ul style="list-style-type: none"> ● The power of the display may switch off with the Power Management function. In such cases, press any key or move the mouse to return to the original display. ● The computer may enter the hibernation mode with the Power Management function. In such cases, press the power switch to return to the original display.
<p>An afterimage appears (i.e., green, red, and blue dots remain on the display) or there are dots not displaying the correct colors</p>	<p>If an image is displayed for a prolonged period of time, an afterimage may appear. This is not a malfunction. The afterimage will disappear when a different screen is displayed. High-precision and advanced technologies are necessary in the production of color liquid crystal displays (color LCDs). Therefore, if 0.002 % or less of the picture elements either fail to light or remain constantly lit (that is, more than 99.998 % of elements are functioning properly), no defect is considered to exist.</p>
<p>The motion of the mouse cursor is not smooth</p>	<p>Select [Start] - [Settings] - [Control Panel] - [Mouse] - [Motion] and add the check mark for [Show pointer trails].</p>

● Character Input

<p>Unable to input anything but numerals</p>	<p>If NumLk are on, the Numeric Key Pad is ON. To switch it OFF, press (NumLk).</p>
<p>Only capital letters are being input</p>	<p>If CapsLock is on, the Caps Lock function is ON. To switch it OFF, press (Caps Lock).</p>
<p>How to input European characters (ß, à, ç) or symbols or Euro Currency Symbol is unclear</p>	<p>Select [Start] - [Programs] - [Accessories] - [System Tools] - [Character Map]. The Character Map will be displayed. Point to the desired font name and select it.</p>

● Disk Operations

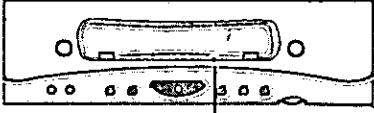
Cannot read/write to a floppy disk	<ul style="list-style-type: none"> ● Has the floppy disk drive been correctly connected? ● Has the floppy disk been correctly formatted? ● Your floppy disk content may be corrupted. ● Is the floppy disk write-protected?
Unable to read/write to the hard disk	<ul style="list-style-type: none"> ● Your drive or file may not have been properly set. ● Check to see if the hard disk is full. If it is full, delete unnecessary files. ● Your hard disk content may be corrupted. Contact Panasonic at 1-800-272-7033.
A CD or DVD cannot be ejected	<p>Is the computer ON? To eject a disc when the computer is OFF, insert the eject pin (included) into the recessed manual disc eject button and pull out the tray.</p>  <p style="text-align: center;">Recessed Manual Disc Eject Button</p>
DVD-ROM indicator lamp (Ⓛ) does not light	Is the disc properly set on the tray?
A CD or DVD disc cannot be played or read	Is the disc deformed? Or, are there marks or dirt on the disc? If there is dirt on the disc, clean the disc (Ⓞ page 24).
A blue background appears on the screen with the MPEG image	Did you open the DVD-ROM drive or remove the disc while it was operating? Re-insert the disc and close the DVD-ROM drive. Press (Enter) .
The vibration of the DVD-ROM drive is large	Are you using a deformed disc or a labeled disc?
The DVD-ROM drive cannot be used in the MS-DOS mode	<p>When using the DVD-ROM drive in the MS-DOS mode, add the necessary driver with the following procedure.</p> <ol style="list-style-type: none"> 1 Select [Start] - [Shut Down]. 2 Select [Restart in MS-DOS mode] and click [OK]. 3 Open the "CONFIG.SYS" file for editing by issuing the following commands: cd \ (Enter) edit config.sys (Enter) 4 Move the cursor to the line containing "OAKCDROM.SYS" and delete the characters "rem" at the beginning of the line. (Deleting "rem" causes the item to become valid.) DEVICEHIGH=C:\WINDOWS\COMMAND\OAKCDROM.SYS /D:MSCD000 (If this line is missing, add it.) 5 Press (Alt) + (F), then (S) to save the file. Then press (Alt) + (F), then (X) to exit the Edit program. 6 Follow the same steps to edit the "AUTOEXEC.BAT" file. edit autoexec.bat (Enter) 7 Move the cursor to the line containing "MSCDEX.EXE" and delete the characters "rem" at the beginning of the line. (Deleting "rem" causes the item to become valid.) LOADHIGH C:\WINDOWS\COMMAND\MSCDEX.EXE /D:MSCD000 /L:L (If this line is missing, add it.) 8 Press (Alt) + (F), then (S) to save the file. Then press (Alt) + (F), then (X) to exit the Edit program. 9 Restart the computer by pressing (Alt) + (Ctrl) + (Del).

● Communication

Unable to connect to the telephone line	<ul style="list-style-type: none"> ● Confirm that the connection between the modem and the telephone line is correct. ● Confirm that the correct type of telephone line has been set. ● Are the communication settings correct?
---	--

● Network

Unable to connect to a network	<ul style="list-style-type: none"> ● When using the computer as a network computer, additional settings may need to be set depending on the usage conditions. Ask your system administrator or the person in charge of the network. ● The computer must be restarted if hibernation mode is entered.
--------------------------------	--

Troubleshooting Suggestions

● Connecting Peripherals

USB device does not work	<ul style="list-style-type: none"> ● Confirm that there is a proper connection with the USB port. ● When connecting a new USB device, be sure to run the USB registry update tool by following the procedure on page 28. ● For USB devices with a power switch, confirm that the switch has been turned on. ● Make sure a driver is installed. ● Contact the manufacturer of the product. ● Some USB devices can only be connected to the USB root hub (☞ page 28).
An error occurs during a resume operation from the hibernation mode when a device is connected to the USB root hub.	<p>Be sure to read page 28 when a device is connected to the USB port.</p>
Unable to print	<ul style="list-style-type: none"> ● Confirm that there is a proper connection with the USB port. ● Make sure the printer is on. ● Make sure the printer driver is properly installed. ● Some USB devices can only be connected to the USB root hub (☞ page 28).
Mouse does not work	<p>Confirm that there is a proper connection with the USB port.</p>
The address map for IRQ, I/O Port address, etc. is unclear	<p>Check the address map by going to [View Resources] in [Start] - [Settings] - [Control Panel] - [System] - [Device Manager] - [Computer] - [Properties].</p>
A PC Card does not work	<ul style="list-style-type: none"> ● Make sure the card is properly inserted. ● Confirm that the card conforms to the PC Card Standard. ● Note that after a driver is installed, the computer must be rebooted. ● Read the PC Card's manual. Or, you may need to call the manufacturer of the PC Card. ● Try removing/reinserting the PC Card by following the proper procedure. (☞ page 31)
A PC Card does not work after resuming from the hibernation mode	<p>When the computer enters the hibernation mode while a PC Card is inserted and then resumes from the hibernation mode, the PC Card may fail to work properly thereafter. In such cases, try removing/reinserting the PC Card by following the proper procedure. (☞ page 31)</p>

● System File Checker

The message [System File Checker identified that the following file may be corrupted] appears	<p>Microsoft Corporation has announced that, with a computer in which Internet Explorer 5.01 is installed, if the [System File Checker] from the [Tools] menu in [Start] - [Programs] - [Accessories] - [System Tools] - [System Information] is executed, the following may occur.</p> <ul style="list-style-type: none"> •The message [System File Checker identified that the following file may be corrupted] may appear for following normal files: <table style="margin-left: 20px; border: none;"> <tr> <td>SETUPX.DLL</td> <td>MSCAT32.DLL</td> <td>MSSIP32.DLL</td> <td>SOFTPUB.DLL</td> </tr> <tr> <td>CRYPTUI.DLL</td> <td>CRYPTNET.DLL</td> <td>CRYPTTEXT.DLL</td> <td>MSOSS.DLL</td> </tr> <tr> <td>MSSIGN32.DLL</td> <td></td> <td></td> <td></td> </tr> </table> •In such cases, there is the possibility that the system will become unstable if the file is repaired with the System File Checker. <p>In this computer, since Internet Explorer 5.01 is the default browser, if the above message [System File Checker identified that the following file may be corrupted] appears for a normal file, select [Ignore] and then press [OK]. Thereafter, do not use the System File Checker.</p>	SETUPX.DLL	MSCAT32.DLL	MSSIP32.DLL	SOFTPUB.DLL	CRYPTUI.DLL	CRYPTNET.DLL	CRYPTTEXT.DLL	MSOSS.DLL	MSSIGN32.DLL			
SETUPX.DLL	MSCAT32.DLL	MSSIP32.DLL	SOFTPUB.DLL										
CRYPTUI.DLL	CRYPTNET.DLL	CRYPTTEXT.DLL	MSOSS.DLL										
MSSIGN32.DLL													

Reinstalling Software

When the contents on the hard disk have been corrupted, it is possible to return the computer to close to the conditions at time of purchase.

CAUTION

When the hard disk is reinstalled, the application programs and data you installed will be erased. Be sure to back up all programs and data beforehand.

Before Reinstallation

NOTE

If data on your hard disk is compressed, uncompress the data.
When compressed files cannot be uncompressed because Windows cannot be started up, select [1. Restore the whole HDD to factory default] in Step 3 of "Reinstallation" (below).

- 1** Turn the computer on
- 2** When [Press <F2> to enter SETUP] message is displayed, press **(F2)**
- 3** Set the Product Recovery CD-ROM in the DVD-ROM drive
- 4** Restart the computer by pressing **(Ctrl) + (Alt) + (Del)**

Reinstallation

- 1** When the [Panasonic] logo is displayed in the center of the screen, press **(Esc)**
- 2** Select [2. DVD Drive] using the **(↑)** and **(↓)** keys from the [Startup menu], and then press **(Enter)**
- 3** Make a selection from the menu
 - To restore all contents of the hard disk to factory default, including the partition setting(s):
Select [1. Restore the whole HDD to factory default].
(When changing the partitions from the factory set partitions, be sure that the C drive partition is set to over 2 GBytes.)
 - To restore the hard disk (C drive) to factory default, excluding the partition setting(s):
Select [2. Restore the drive C to factory default].
 - To stop the reinstallation:
Select [3. End].

Reinstalling Software

4 At the confirmation message “[Y,N]?” press **Y**

The operations of “format” and “restore” for the hard disk start automatically. (The operations take about one hour.)

When the reinstallation completes, the following message will appear on the display.

All data on the whole HDD has been restored to the factory default. After removing Product Recovery CD-ROM, restart the computer and set up Windows again.
--

5 Remove the Product Recovery CD-ROM, then close the tray

6 Restart the computer by pressing **Ctrl** + **Alt** + **Del**, and perform the setup procedure for Windows by following the instructions on the screen (☞ page 14)

LIMITED USE LICENSE AGREEMENT

THE SOFTWARE PROGRAM(S) ("PROGRAMS") FURNISHED WITH THIS PANASONIC® PRODUCT ("PRODUCT") ARE LICENSED ONLY TO THE END-USER ("YOU"), AND MAY BE USED BY YOU ONLY IN ACCORDANCE WITH THE LICENSE TERMS DESCRIBED BELOW. YOUR USE OF THE PROGRAMS SHALL BE CONCLUSIVELY DEEMED TO CONSTITUTE YOUR ACCEPTANCE OF THE TERMS OF THIS LICENSE.

Matsushita Electric Industrial Co., Ltd. ("MEI") has developed or otherwise obtained the Programs and hereby licenses their use to you. You assume sole responsibility for the selection of the Product (including the associated Programs) to achieve your intended results, and for the installation, use and results obtained therefrom.

LICENSE

- A. MEI hereby grants you a personal, non-transferable and non-exclusive right and license to use the Programs in accordance with the terms and conditions stated in this Agreement. You acknowledge that you are receiving only a LIMITED LICENSE TO USE the Programs and related documentation and that you shall obtain no title, ownership nor any other rights in or to the Programs and related documentation nor in or to the algorithms, concepts, designs and ideas represented by or incorporated in the Programs and related documentation, all of which title, ownership and rights shall remain with MEI or its suppliers.
- B. You may use the Programs only on the single Product which was accompanied by the Programs.
- C. You and your employees and agents are required to protect the confidentiality of the Programs. You may not distribute or otherwise make the Programs or related documentation available to any third party, by time-sharing or otherwise, without the prior written consent of MEI.
- D. You may not copy or reproduce, or permit to be copied or reproduced, the Programs or related documentation for any purpose, except that you may make one (1) copy of the Programs for backup purposes only in support of your use of the Programs on the single Product which was accompanied by the Programs. You shall not modify, or attempt to modify, the Programs.
- E. You may transfer the Programs and license them to another party only in connection with your transfer of the single Product which was accompanied by the Programs to such other party. At the time of such a transfer, you must also transfer all copies, whether in printed or machine readable form, of every Program, and the related documentation, to the same party or destroy any such copies not so transferred.
- F. You may not remove any copyright, trademark or other notice or product identification from the Programs and you must reproduce and include any such notice or product identification on any copy of any Program.

YOU MAY NOT REVERSE ASSEMBLE, REVERSE COMPILE, OR MECHANICALLY OR ELECTRONICALLY TRACE THE PROGRAMS, OR ANY COPY THEREOF, IN WHOLE OR IN PART.

YOU MAY NOT USE, COPY, MODIFY, ALTER, OR TRANSFER THE PROGRAMS OR ANY COPY THEREOF, IN WHOLE OR IN PART, EXCEPT AS EXPRESSLY PROVIDED IN THE LICENSE.

IF YOU TRANSFER POSSESSION OF ANY COPY OF ANY PROGRAM TO ANOTHER PARTY, EXCEPT AS PERMITTED IN PARAGRAPH E ABOVE, YOUR LICENSE IS AUTOMATICALLY TERMINATED.

TERM

This license is effective only for so long as you own or lease the Product, unless earlier terminated. You may terminate this license at any time by destroying, at your expense, the Programs and related documentation together with all copies thereof in any form. This license will also terminate effective immediately upon occurrence of the conditions therefor set forth elsewhere in this Agreement, or if you fail to comply with any term or condition contained herein. Upon any such termination, you agree to destroy, at your expense, the Programs and related documentation together with all copies thereof in any form.

YOU ACKNOWLEDGE THAT YOU HAVE READ THIS AGREEMENT, UNDERSTAND IT AND AGREE TO BE BOUND BY ITS TERMS AND CONDITIONS. YOU FURTHER AGREE THAT IT IS THE COMPLETE AND EXCLUSIVE STATEMENT OF THE AGREEMENT BETWEEN US, WHICH SUPERSEDES ANY PROPOSAL OR PRIOR AGREEMENT, ORAL OR WRITTEN, AND ANY OTHER COMMUNICATIONS BETWEEN US, RELATING TO THE SUBJECT MATTER OF THIS AGREEMENT.

Installing Windows 98 Related Files

Follow the steps below if you want to install the files in the following folders (not installed at the factory).

\add-ons \tools \drivers

A sufficient amount of free space in the C drive of the hard disk is necessary to install the files.

1 Install the driver to use the DVD-ROM drive in the MS-DOS mode
(☞ page 55)

2 Turn the computer on

3 If the [Panasonic] logo disappears, immediately press **Ctrl** key
(until the menu is displayed)

NOTE

If the Windows desktop display appears, reboot the computer.

4 Select [Command prompt only]

5 Set the Product Recovery CD-ROM in the DVD-ROM drive

6 After C:\>, type in the following
L:AEN\ADDFILE **Enter**

NOTE

[L:] is the character assigned for the DVD-ROM drive. You may make a change depending on the usage conditions of the computer.

7 Follow the on-screen instructions

With the above command, the files will be installed in the [C:\util\win98add] folder.

Specifications

● Main Specifications

Model No.		CF-E1M
CPU		Intel® Celeron™ Processor 400 MHz L1 Cache Memory: 64 KB L2 (Second) Cache Memory: 128 KB
Memory (Expandable to)*1		64 MB (192 MB Max.)
Video Memory		4 MB
LCD	Type	15.0 Type (TFT) XGA
	Displayed Colors*2	262144 colors (1024 X 768 pixels)
Hard Disk Drive (including about 200 MB used specifically by the system)		6.4 GB*2

*1 Usage limited to a synchronous DRAM or self-refresh module.

*2 A 16 M color display on the LCD is achieved by using the FRC function.

*3 1 GB = 10⁹ bytes

● Other Specifications

Keyboard	USB compatible keyboard 87 keys		
Pointing Device	USB compatible mouse with a scroll button		
External Floppy Disk Drive	720 KB (2DD) / 1.44 MB (2HD)		
DVD-ROM Drive	6X DVD-ROM Drive / 32X CD-ROM Drive max. speed		
Slots	PC Card Slots	Type I or Type II	
		Allowable current (1 slot)	3.3 V: 500 mA, 5 V: 400 mA
	RAM Module Slot	144-pin, SO-DIMM, 3.3 V, SDRAM	
Interface	Microphone Jack*1	Miniature jack, 3.5 DIA	
	Headphone Jack	Miniature jack, 3.5 DIA	
	Optical Digital Audio Output Terminal X1		
	IEEE 1394 Interface Connector	4 pin male X2 (IEEE 1394 standards)	
	USB Port	4-pin Universal Serial Bus X 4 (Free: 2 port)	
Internal Modem	Data:56 kbps (V.90 & K56flex) FAX:14.4 kbps		
Internal Microphone	Monaural Microphone (built in)		
Speaker	Stereo Speaker X 2 (built in)		
Sound	16 bits, 44.1 kHz PCM/FM sound (Windows Sound Systems Compatible)		
Software	Operating System	Microsoft® Windows® 98 Second Edition	
	Application Programs	DV Capture, ImageBrowser, Movie Messenger, Adobe® Acrobat 4.0, VisualBright, WinDVD™2000*2	
Power Supply Unit (built in)	Input: 120 V AC*3, 60 Hz		
Power Consumption	Approx. 70 W*4		
Physical Dimensions (W X H X D)*5	389 mm X 275 mm X 388 mm {15.3 " X 10.8 " X 15.3 "}		
Weight	Approx. 8.6 kg {Approx. 18.9 lb.}		
Operating temperature/ Humidity range	5 °C to 35 °C {41 °F to 95 °F} / 30 % to 80 % RH (no condensation)		

*1 Use only a monaural condenser microphone (miniature jack).

*2 It is necessary to install WinDVD™2000.

*3 AC cord is supplied with a 125 V AC compatible.

*4 Approx. 1.2 W when the computer is OFF.

*5 This "height" is when the stand is in use.

LIMITED WARRANTY

For U.S.A.

PANASONIC AV PLATFORM COMPUTER LIMITED WARRANTY

Panasonic Consumer Electronics Company (referred to as "Panasonic") will repair this product (other than software, which is covered by a separate warranty) with new or rebuilt parts, free of charge in the U.S.A. for one (1) year from the date of original purchase in the event of a defect in materials or workmanship.

This warranty is extended solely to the original purchaser. A purchase receipt or other proof of date of original purchase will be required before warranty performance is rendered.

This warranty only covers failures due to defects in materials or workmanship which occur during normal use. It does not cover damage which occurs in shipment or failures which are caused by products not supplied by Panasonic, or failures which result from alteration, accident, misuse, introduction of liquid or other foreign matter into the unit, abuse, neglect, installation, maladjustment of consumer controls, improper maintenance, modification or service by anyone other than an authorized Panasonic Service Center, or damage that is attributable to acts of God.

Limits and Exclusions:

There are no other express warranties except as listed below.

PANASONIC SHALL NOT BE LIABLE FOR LOSS OF DATA OR ANY INCIDENTAL OR CONSEQUENTIAL DAMAGES RESULTING FROM THE USE OF THIS PRODUCT, OR ARISING OUT OF ANY BREACH OF THIS WARRANTY. ALL EXPRESS AND IMPLIED WARRANTIES, INCLUDING THE WARRANTIES OF MERCHANTABILITY AND FITNESS FOR A PARTICULAR PURPOSE ARE LIMITED TO THE APPLICABLE WARRANTY PERIOD SET FORTH ABOVE. Some states do not allow the exclusion or limitation of incidental or consequential damages, or limitations on how long an implied warranty lasts, so the above limitations or exclusions may not apply to you.

This limited warranty gives you specific legal rights, and you may also have other rights which vary from state to state. If a problem with your product develops during the warranty period, you may contact our representatives at 1-800-272-7033. If the problem is not handled to your satisfaction, then write to the Consumer Affairs Division at the address indicated below.

SOFTWARE LIMITED WARRANTY

Panasonic Consumer Electronics Company (referred to as "Panasonic") warrants to you only that the disk(s) or other media on which the Programs are furnished will be free from defects in materials and workmanship under normal use for a period of sixty (60) days from the date of delivery thereof to you, as evidenced by your purchase receipt.

This is the only warranty Panasonic makes to you. Panasonic does not warrant that the functions contained in the Programs will meet your requirement or that the operation of the Programs will be uninterrupted or error free.

Panasonic's entire liability, and your exclusive remedy under this warranty shall be limited to the replacement, in the United States, of any defective disk or other media which is returned to Panasonic's Authorized Service Center, together with a copy of the purchase receipt, within the aforesaid warranty period.

Anything in the foregoing to the contrary notwithstanding, Panasonic shall have no obligation for any defects in the disk(s) or other media on which the Programs are furnished resulting from your storage thereof, or for defects that have been caused by operation of the disk(s) or other media otherwise than on the Product or in environmental conditions other than those specified by Panasonic by alteration, accident, misuse, abuse, neglect, mishandling, misapplication, installation, maladjustment of consumer controls, improper maintenance, modification of damage that is attributable to acts of God. In addition, Panasonic shall have no obligation for any defects in the disk(s) or other media if you have modified, or attempted to modify any Program.

DURATION OF IMPLIED WARRANTIES, IF ANY, IS LIMITED TO SIXTY (60) DAYS.

PANASONIC ASSUMES NO RISK OF AND SHALL NOT IN ANY CASE BE LIABLE FOR ANY DAMAGES, INCLUDING, WITHOUT LIMITATION, ANY SPECIAL, INCIDENTAL, CONSEQUENTIAL, OR PUNITIVE DAMAGES ARISING FROM BREACH OF WARRANTY OR CONTRACT, NEGLIGENCE OR ANY OTHER LEGAL THEORY, INCLUDING, WITHOUT LIMITATION LOSS OF GOODWILL, PROFITS OR REVENUE, LOSS OF USE OF THE PROGRAMS OR PRODUCTS OR ANY ASSOCIATED EQUIPMENT, COST OF CAPITAL, COST OF ANY SUBSTITUTE EQUIPMENT, FACILITIES, SERVICES, DOWNTIME COSTS, OR CLAIMS OF ANY PARTY DEALING WITH YOU FOR SUCH DAMAGES.

Some states do not allow the exclusion or limitation of incidental or consequential damages, or limitations on how long an implied warranty lasts, so the above limitations or exclusions may not apply to you.

This limited warranty gives you specific legal rights, and you may also have other rights which vary from state to state.

This Limited Warranty will be governed by the laws the State of New York, without regard to its conflict-of-laws rules.

* * *

To obtain service or technical assistance during the warranty period within the continental U.S.A. and Alaska:

DIAL TOLL FREE: 1-800-272-7033

To obtain support or service following the warranty period within the continental U.S.A. and Alaska:

DIAL: 1-900-555-PANA (1-900-555-7262) for fee based technical support

Correspondence requesting product information should be sent to: Panasonic Consumer Electronics Company, One Panasonic Way, Panazip 1D-1, Secaucus, NJ 07094

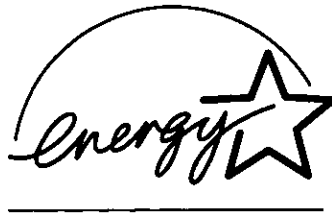

As an ENERGY STAR® Partner, Matsushita Electric Industrial Co., Ltd. has determined that this product meets the ENERGY STAR® guidelines for energy efficiency.

Outline of the International ENERGY STAR® Office Equipment Program

The international ENERGY STAR® Office Equipment Program is an international program that promotes energy saving through the use of computers and other office equipment. The program backs the development and dissemination of products with functions that effectively reduce energy consumption. It is an open system in which business proprietors can participate voluntarily. The targeted products are office equipment such as computers, displays, printers, facsimiles, and copiers. Their standards and logos are uniform among participating nations.

Panasonic Consumer Electronics Company,
Division of Matsushita Electric Corporation of America
One Panasonic Way
Secaucus, New Jersey 07094

